



**CEEPR**

**Center for Energy and Environmental Policy Research**

**ELECTRICITY NETWORK TARIFF  
ARCHITECTURES  
A Comparison of Four OECD Countries**

**by  
Vivek Sakhrani and John E. Parsons**

**10-008**

**July 2010**

**A Joint Center of the Department of Economics,  
MIT Energy Initiative, and Sloan School of Management**



# ELECTRICITY NETWORK TARIFF ARCHITECTURES

## A Comparison of Four OECD Countries

Vivek Sakhrani \* and John E. Parsons \*\*

### Abstract

The study is motivated by the question “what is the optimal tariff design?” While we do not offer an answer to this question, we use the different designs in four select countries to illuminate the issues involved in designing electricity network tariffs. Electricity networks are a resource shared by all network users. A tariff design that is clear to network users and well understood by them can help them make efficient decisions. A design that sets up conflicting or perverse incentives results in economic distortions. We find that there are a variety of choices and trade-offs while designing the electricity network tariffs for any electricity system. The tariff design must not only be influenced by the technical and economic characteristics of the system, but also the secondary policy objectives that policy makers wish to achieve, while allowing network companies to recover the costs of building and maintaining the network.

\* Corresponding author, MIT Technology and Policy Program and the MIT Center for Energy and Environmental Policy Research, Massachusetts Institute of Technology, E19-411, 77 Massachusetts Ave., Cambridge, MA 02139, Email: [sakhrani@mit.edu](mailto:sakhrani@mit.edu)

\*\* MIT Sloan School of Management, MIT Center for Energy and Environmental Policy Research, and MIT Joint Program on the Science and Policy of Global Change, Massachusetts Institute of Technology, E19-411, 77 Massachusetts Ave., Cambridge, MA 02139, Email: [jparsons@mit.edu](mailto:jparsons@mit.edu)

# TABLE OF CONTENTS

<b>Table of Contents .....</b>	<b>2</b>
<b>PART I : THEORETICAL OVERVIEW .....</b>	<b>4</b>
<b>Purpose of the Study.....</b>	<b>4</b>
<b>1. Network Characteristics.....</b>	<b>5</b>
1.1 Natural Monopolies .....	5
1.2 A Shared Resource.....	6
1.3 A Basis for Incentives .....	8
<b>2. Tariffs .....</b>	<b>10</b>
2.1 Tariff Architecture .....	10
2.2 Tariff Types.....	15
2.3 Regulatory Drivers .....	17
<b>3. Issues related to Tariff structure .....</b>	<b>19</b>
3.1 Choice of Principles .....	19
3.2 Siting of Generation.....	21
3.3 Selection and Scale of Generation Technology .....	21
3.4 Maintaining Quality of Service .....	22
3.5 Ensuring Adequacy of Capacity .....	23
3.6 Cross-subsidization of Tariffs .....	24
3.7 Incidence of Energy Policy Costs .....	24
<b>PART II : COUNTRY STUDIES.....</b>	<b>26</b>
<b>New England (USA) .....</b>	<b>26</b>
<b>1. System Characteristics .....</b>	<b>26</b>
1.1 Generation.....	27
1.2 Networks .....	29
<b>2. Tariffs .....</b>	<b>31</b>
2.1 General Tariff Design .....	32
2.2 Transmission Network Tariffs.....	34

2.3	Distribution Network Tariffs .....	36
<b>Australia</b> .....		<b>41</b>
<b>1. System Characteristics</b> .....		<b>41</b>
1.1	Generation.....	43
1.2	Networks .....	44
<b>2. Tariffs</b> .....		<b>52</b>
2.1	National Electricity Market.....	52
2.2	Western Australia .....	57
2.3	Northern Territories.....	62
<b>Portugal</b> .....		<b>65</b>
<b>1. System Characteristics</b> .....		<b>65</b>
1.1	Generation.....	65
1.2	Networks .....	70
<b>2. Tariffs</b> .....		<b>73</b>
2.1	General Tariff Design.....	74
2.2	Rate Design.....	76
2.3	ToLR Distortions .....	79
<b>Spain</b> .....		<b>82</b>
<b>1. System Characteristics</b> .....		<b>83</b>
1.1	Generation.....	83
1.2	Networks .....	85
<b>2. Tariffs</b> .....		<b>88</b>
2.1	General Tariff Design.....	89
2.2	Rate Design.....	93
2.3	ToLR Distortions .....	97
<b>Concluding Remarks</b> .....		<b>103</b>
<b>References</b> .....		<b>107</b>
General .....		107
Agency Sources .....		108

---

## PART I : THEORETICAL OVERVIEW

---

### PURPOSE OF THE STUDY

The study is motivated by the question “what is the optimal tariff design?” While we do not offer an answer to this question, we use the different designs in four select countries to illuminate the issues involved in designing electricity network tariffs. Transmission and distribution networks are characterized by a number of important technical and economic features that shape the regulatory institutions used to manage the networks. In turn, the chosen regulatory institutions influence the design of electricity network tariffs.

Electricity networks are a resource shared by all network users. Decisions must be made about what costs are to be incurred and how those costs are to be shared across different users. These are complicated decisions. Network tariffs can be organized to include charges for bundles of services or to include separate charges for distinct services. These charges can be conditioned on various measures of the customer’s use of the network, or the costs that the customer imposes on the network. The tariff design shapes incentives for the use and expansion of the system, which further influences costs. A tariff design that is clear to network users and well understood by them can help them make efficient decisions. A design that sets up conflicting or perverse incentives results in economic distortions.

A main constraint on the tariff design is the overall budget constraint: the total of all charges to all users must be sufficient to cover the costs of the network and afford the network company an adequate return on its capital. On the other hand, the total of all charges should be kept reasonable, in the sense that the network company is not extracting monopoly profits.

Transmission networks are different from distribution networks in terms of their technical requirements and usage patterns. Tariffs may therefore be designed differently for the two types of networks to provide specific incentives to the respective users. We discuss tariff designs for both types of networks.

To set the stage for the description of alternative tariff designs, it is beneficial to revisit the issues arising out of the economic characteristics of electricity networks and the consequent regulatory provisions.

# **1. NETWORK CHARACTERISTICS**

## **1.1 Natural Monopolies**

Electricity networks - both transmission and distribution - are treated as natural monopolies because of the existence of economies of scale and scope in the delivery of electricity. Economies of scale exist when a firm's average cost of production declines as output increases. Economies of scope exist when it is cheaper to produce combinations of different products within a single multi-product firm, than to have specialty firms produce the different products (Panzar and Willig 1981).

Electricity networks achieve economies of scale when their capacity is sized to meet the demand for all network users within their network territory. For a given network capacity, the average cost of production decreases as the capacity utilization increases, and is lowest when utilization is maximized. The average cost of production is lowest if the network company sells to the entire market, that is, when it meets the total demand. Competition in electricity networks for a particular service territory, especially in distribution networks, is economically inefficient because small competing firms would be required to make large redundant investments to reach a relatively small number of customers in that territory (Kahn 1988).

Electricity delivery is multi-product because delivering electricity at peak and off-peak hours to customers or to customers located in different regions can be considered as supplying different products. However, a network company needs to have only one network in place to supply all the products. The company can therefore realize economies of scope, even if minimal economies of scale are associated with one of its many products, such as delivering electricity at non-peak times of the day. Monopoly is thus natural because one network firm can serve a range of products to any number of customers in a given territory at lower cost than two or more firms (Joskow and Schmalensee 1983).

A monopolistic electricity delivery company could charge prices that are much higher than the cost of delivery. Network company revenues from electricity sales are therefore regulated to ensure that they do not significantly exceed the cost of delivery. The network company is also mandated to serve all customers, both generators and consumers, according to standards and rules established by the regulatory authorities. Regulated revenues must be sufficient to allow the recovery of operating and capital costs, including a reasonable rate of return on investments, to ensure the financial viability of the company in the short-run (Rothwell and Gomez 2003). Regulated revenues are therefore also termed as required revenues, to indicate the sufficiency criteria of the total revenues of the network company.

The choice of natural monopoly regulation as the framework for network governance implies that the regulator must participate in certain key decisions affecting the network. In doing so, the regulator acts on behalf of electricity customers, and its choices will influence the costs that various network users will ultimately incur. The decision of what investments the network company is allowed to make is an

illustration of regulatory participation. The large capital costs of equipment such as lines, transformers, sub-stations, communication and protection devices, control mechanisms, etc is much higher than the recurring operating costs of the network. The expected useful life of assets is also quite long, usually at least 30 to 40 years. Network assets are also dedicated, i.e. they cannot be easily moved or re-deployed for other purposes. Thus, the natural monopoly network owner will invest in setting up and maintaining the network only if it is assured of cost recovery. By approving investments through the revenue requirement, the regulator establishes the prudence of investments and an assurance of cost recovery for the network company.

A regulated natural monopoly must also be given incentives to operate efficiently. This is especially important in restructured markets where network companies are legally separate from generation companies, because the actions of network companies have an impact on generation and network usage in the system. Coordination across the different types of entities must be achieved through appropriate incentives. This topic is discussed in the following sections.

## **1.2 A Shared Resource**

Electricity networks are a shared resource and a public good. Many decisions about the design of the network determine the volume and quality of service that all users will enjoy, and must be made on behalf of all. Quite often, the cost of providing service to one user depends on the services being provided to other users, and also upon how other users are using the system.

The shared nature of the network complicates the answers to the questions of what network to build, which connections to enable, and what quality of service to provide. There are joint decisions to be made on the quality of service to be provided and on the network structure, which imposes different costs on various users. There are individual decisions of the users who will interact with the network, and in doing so, impose costs on the system as a whole and on other users. Because of the long life of network assets and their immovability, many of the decisions will impact future customers, and the regulator must be able to take decisions now on their behalf. The flip side of this issue is the question of how to share the burden of paying for the network? Can users be charged according to the benefits they receive from the system or according to the costs they impose on it? What principles define the allocation of cost and benefits to various network users? A few examples are discussed here that illustrate the nature of electricity networks as a shared resource and the difficulty in clearly assigning costs and benefits.

Some industrial end-use customers such as manufacturers value high power quality much more than the average customer. The network company may have to invest in dedicated assets or modify its operations solely for the purpose of providing higher power quality to such customers. Where they are isolated or at



a distance from the main network, the costs of dedicated assets could be allocated to the individual customer. In areas where such industrial customers are in the same part of the network as other average commercial or residential customers, these other end-users may also benefit from the installation of dedicated assets. Should these users be responsible for higher charges for a service they do not need?

All network users indirectly benefit from reliability-related network reinforcements, but it is hard to determine how much each user should be charged for such costs. For instance, the addition of a transmission line to relieve congestion or transmission constraints in one region of an existing network might alter the power flows and decrease the costs of delivering service not only in that region but also in other parts of the network. In this scenario, should the costs be allocated only to users in the previously congested area? Should users in previously uncongested parts who did not experience problems with network service and did not need the new transmission line also be charged? If yes, then on what basis and how much? In both cases, some users might be subsidizing the cost of reliable electricity service to others. Thus, clearly assigning benefits and costs in situations where the benefits are distributed to a large part of the network is difficult.

When some network users such as distributed generators impose high reinforcement and operating costs on the distribution system, the charges for other end-use customers in the distribution company's service territory might increase. If the distributed generator is charged for all of the connection and reinforcement costs, it will subsidize some of the reliability benefits to other customers, as discussed in the transmission case above. If the generator is not charged for all of those reinforcements, then other customers could be overpaying for some of the benefits. Thus, connecting some types of network users may bring benefits but also impose costs on other users. How is a system to explicitly allocate these?

Network investments selected today must anticipate the uncertain long-term future needs of the system. This is because the availability of equipment in only a limited number of standardized capacity ratings makes it difficult to size new capacity additions to exactly match expected utilization or to add capacity incrementally, especially at the transmission level. As discussed above, economies of scale may also be realized if the network company meets all of the future demand for network use. New network investments are therefore sized to meet forecasted long-term capacity requirements and occur infrequently and in large blocks. However, if the realized network use differs significantly from the forecasts, then some assets may become "stranded." The trade-off is between minimizing network costs today and undertaking larger investments motivated by economies of scale over the life of the asset. Consequently, how will network users decide to pay for the cost of assets allocated to them today that may not be as valuable in the uncertain future?

Network losses on transmission and distribution systems are not a simple function of the power bought and sold at any two points on the network between individual generators and consumers. The losses

depend on the structure of all the inputs and withdrawals of power in the network. How then are the costs of losses to be allocated to network users?

The cost of providing service to one user is thus rarely independent of the services being provided to other users and the usage of the network as a whole. However, in many of the examples discussed, differentiating between every customer may not be essential. For instance, residential customers who might make up the large majority of customers enjoy an almost identical level of quality of service. Establishing a minimum quality of service will therefore benefit all these customers, and the costs can be recovered from all. Industrial end-users who prefer higher quality of service can choose to pay for dedicated network assets located close to their facilities without imposing costs on other customers. Such differentiation might therefore create opportunities for flexibility in tariff design.

### **1.3 A Basis for Incentives**

Network cost allocation is thus a complex task, due to the shared nature of networks. It is also incomplete without an adequate consideration of the incentives that have been created for the network company and various network users. Incentives are important in restructured markets because the benefits of competition are realized when actions of various entities in the electricity system are well coordinated. In vertically integrated systems, the regulator could force coordination between one or a few entities, since decisions of investments and operations of generation and networks were largely made within the vertically integrated firm. In restructured systems, generation firms are independent of networks and operate in a market framework. Many systems have also separated distribution from retail supply of electricity to end-use customers. The larger number of agents and the diversity of regulatory frameworks necessitate a hard look at the incentives faced by various entities. Understanding the shared nature of networks is therefore a pre-requisite for the creation of appropriate incentives.

A few of the ways in which the cost of providing service to one user is shaped by overall system use, both in the short-run and the long-run, are described here.

#### **1.3.1 Short-run Influences**

When a new generator connects to the system, there are some straightforward costs of wiring and equipment directly related to the connection between the generator and its point of connection with the network system. However, the new generator connection at that location may significantly affect the power flows over the entire network. This change in flow patterns may require upgrades and

reinforcements elsewhere in the network. The term “shallow costs” is used to differentiate between the set of direct connection costs, excluding the cost of system-wide reinforcements, from the set of “deep costs” which includes the cost of necessary reinforcements. An important choice to be made in such cases is whether the connecting generator should be charged for the shallow costs of the network connection, or the more inclusive deep costs. This example also applies to new consumer connections, or new interconnections with adjacent networks.

### **1.3.2 Long-run Influences**

Investments in generation and transmission may be coordinated in order to minimize the size of investments required in each. To some degree, expanded levels of generation require expanded transmission capacity. But generation and transmission can also substitute for one another. A properly placed transmission line can alleviate congestion and reduce the need for new generation in other parts of the network. It may also change the distribution of load and power flows across the network and lower the overall level of losses in the system. The careful placement and capacity of transmission lines influences network reliability and may enable load to be served at the same quality of service without requiring additional generators or ancillary services.

In some aspects, the cost responsibility is easier to assign. For instance, network users can be held responsible for the direct costs of connecting to the network, which enables them to accrue the benefits of the network. But it is much more difficult to assess a single new user’s contribution to the network reinforcements required at higher voltage levels when the user connects at a lower voltage level. Furthermore, all existing users connected at that level benefit from reinforcements at higher levels. In this case, the electricity system could choose whether to assign responsibility to only the new user or all existing users for the cost of reinforcements.

Standards for reliability and quality of service are largely based on the preferences of consumers in an electricity system. If a certain level of reliability or quality of service for electricity delivery is standardized or mandated, all network users benefit from it. However, such standards influence the costs incurred in operation and maintenance of networks. But calculating the marginal cost of reliability or quality of service for a single new user is not feasible, because other users also benefit from increased reliability and quality standards. The marginal costs and benefits for particular users could be approximated using an instrument such as a reference network model, which simulates the conditions of the real network under a variety of scenarios and attempts to estimate the value of the network to various users. However, such a model becomes difficult to implement as the complexity of the network and number of users increases. The difficulty of assigning cost responsibility to users in the form of marginal costs and

benefits necessitates that electricity systems must choose other methods that will allow for the eventual recovery of network costs.

Addressing cost allocation in the context of shared natural monopoly networks and the need to create appropriate incentives for various users are thus the underlying issues that influence the mechanisms for network tariff design.

## **2. TARIFFS**

The central choice of any tariff design is deciding how to differentiate between various types of network usage for the dual purpose of allocating network costs and creating appropriate incentives. The important objective is to establish a process for determining who pays for what services and how much. Electricity systems have a significant degree of flexibility with regard to how tariffs are designed, bearing in mind the cost categories discussed above and the shared nature of networks. Systems could distinguish between generators and end-use customers for the purposes of cost allocation; for example, generators may not be required to pay network tariffs. Systems could also vary charges by connection capacity (MW), such that large consumers with a higher demand for electricity pay more. Alternatively, distinguishing between customers by the amount of consumption (MWh) will require those consuming higher volumes of electricity to pay more. The incentives established will be a consequence of the design selected. The following discussion illustrates some of the available design choices.

### **2.1 Tariff Architecture**

Within the class of network tariffs, a number of typical architectural elements for different services are prevalent such as (i) connection services, (ii) use of the network system, (iii) commercial services, etc. For each of these elements, the question of what methodology or formula to use must be addressed. The typical design choices for each element are summarized in Table 1.

**Table 1. Choices and Variations for Architectural Elements**

<b>Element</b>	<b>Purpose</b>	<b>Design Choices</b>	<b>Variations</b>
Connection Charge	to recover the initial, non-recurring connection costs for enabling the user to receive network services	- shallow - deep - average	may be levied - up front - in limited installments - periodically
Use-of-System Charge	to recover the recurring operating and capital costs for network maintenance and expansion	- reference network model - postage stamp - megawatt mile - contract path - decoupling - gross- or net-metering	may be differentiated by - capacity demand (MW) - consumption (MWh) - time of day - season - average per connection
Commercial Services Charge	to recover the cost of services such as billing, customer support, etc	- average - transaction fees	- minimum fee - maximum fee
Energy Policy Charge	to recover the cost of policy outcomes such as nuclear moratoria or decommissioning, cross-subsidization of low income or rural communities, stranded costs of restructuring, feed-in tariffs for renewables, etc	- average fee - lump sums	- increasing over time - decreasing over time

### 2.1.1 Connection Charges

Network users can be required to pay an initial, non-recurring connection charge to cover the cost of connecting to the network in order to receive network services. Generators usually pay to connect to the transmission network. Consumers usually pay to connect to the distribution network at low voltage levels, and in some cases at higher voltage levels. A new network connection may have a physical or technical impact on the rest of the network in terms of reliability or quality of service, especially when the connections are large as in the case on generators. A system impact study is usually conducted to evaluate the type and extent of network reinforcements that may be required at different network levels to ensure reliability and quality of service. Electricity system regulations must have a provision for the recovery of costs associated with reinforcements. In cases where network users are responsible only for shallow network charges, the cost of reinforcements must be recovered from all other network users. Systems could require new connectors to pay for a small or large fraction of the reinforcement costs. Alternatively, new users could be charged the average of the total connection cost due to all new users connecting during a given time period.

## **2.1.2 Use of System (UoS) Charges**

Network users can be required to pay UoS charges as part of the network tariff to recover the recurring operating and capital expenses incurred in network operation and investment. The primary network-related costs for network owners and operators, both transmission and distribution, can be categorized as follows:

### **Capital or Fixed Costs**

- Network infrastructure including wires, substations, transformers, etc
- New connections to generators, customers, or adjacent networks
- Reinforcement of existing infrastructure by adding wires, transformers, etc
- Debt financing costs, required returns on capital

### **Operating Costs**

- Maintenance of network infrastructure
- Scheduling and dispatch services
- Network related ancillary services such as voltage control, etc
- Network company's administrative expenses
- Taxes

The required revenues must cover the operating and capital expenses of networks in the short- and long-run such as maintenance of networks, providing access to users, ensuring adequate network capacity, meeting specifications for reliability and quality of service, etc.

At the transmission level, a number of cost allocation methods such as *postage stamping*, *megawatt-mile*, *contract path* have been proposed or used in various systems. The use of reference network models, and mechanisms such as decoupling, gross-metering and net-metering is observed at the distribution level (Rothwell and Gomez 2003, Kirschen and Strbac 2004).

#### **2.1.2.1 Postage Stamping**

In a method like postage stamping, the UoS charges are uniform across the entire transmission system, irrespective of the location of a network user, as long as the usage remains within the local system. The

charge may vary with capacity ratings of generators or peak demand ratings of consumers (MW). The charge may also be a function of energy consumption (MWh). As a result, the system could choose to have both fixed and variable components (MW and MWh) in its UoS charges. To further reflect the usage of different consumer types, charges could be differentiated by voltage levels. Irrespective of the specific design, network users pay an average charge that does not identify the cost incurred to supply network services to a particular user. Postage stamping is popular because of its simplicity, but does not provide cost-reflective signals to the network user.

#### ***2.1.2.2 Megawatt-Mile or Contract Path***

In transmission cost allocation methods like contract path or megawatt mile, assumptions are made about the power flow between a generator and a consumer and the users are responsible for costs related to only those network facilities that are in the path of power flow. Users are therefore charged for the use of specific facilities and not the average cost of the entire network. These methods are error-prone because the realized or actual physical path of power flow follows Kirchoff's laws and may differ significantly from the assumed contract path. In such cases the UoS charges can become severely distorted.

#### ***2.1.2.3 Reference Network Model***

At the distribution level, the marginal costs for particular users could be approximated using an instrument such as a reference network model, which simulates the conditions of the real network under a variety of scenarios. Such a model attempts to estimate the economic value of network assets to various network users by considering physical power flows, equipment capacities, location of network users and additional phenomena such as load fluctuations and congestion. The model resembles the topography of the existing network with the corresponding loads and generators. The performance of the real network is evaluated as a whole by comparing it to the model results of existing network conditions. As a result, this method allows for sophisticated charging schemes that generally reflect the costs incurred to provide network services to particular users. A reference network model becomes harder to implement as the complexity of the network and the number of network users increases, but this is also when it becomes most valuable for cost allocation.

#### ***2.1.2.4 Gross- or Net-Metering***

Methods such as gross-metering or net-metering are relevant when generation is located at the customer site as with distributed generation. In some cases, the generator may routinely consume more electricity than it can produce; the withdrawal from the main network is therefore offset but the customer does not input electricity into the network. A standard, unidirectional metering method is not an issue in such cases. However, some alternative method could be adopted when the generator does input electricity into the network, by using a bi-directional meter (net) or even separate meters (gross) for measuring flow

into and from the network. Once the mechanism for measuring the flows has been selected, the issue of compensating the generator arises. Some possible choices for compensation are: (i) no compensation, (ii) below the retail rate (wholesale rate, avoided cost rate, etc) (iii) retail rate, or (iv) at a premium rate. The initial choice of gross or net metering influences the outcome of the compensation method. For instance, the metered input could be paid a wholesale charge if gross metering (also called net billing) is selected, because two separate meters or accounts are being maintained for each direction of flow. On the other hand, when the meter “runs backwards,” it is not possible to measure the counter-factual amount of electricity that the customer would have consumed if it wasn’t supplying electricity back to the grid. Thus, pricing the electricity at any single rate, say wholesale or retail, introduces some distortions. For either the gross or net system of measurement, more sophisticated methods may be instituted such as rolling credits, banking and buy-back. The choice of metering and compensation methods has implications for the scale and technology selection of distributed generation.

#### ***2.1.2.5 Decoupling***

Decoupling is a method in which the revenues and profits of the network company are separated from the volume of energy sold. In principle, the method makes utilities indifferent from sales fluctuations, and allows them to reduce network costs by encouraging network users to reduce their overall network usage through decreased electricity consumption. As the rate is not calculated based on the MWh usage of networks, the network company’s revenues do not depend on the amount of electricity sold to customers. Two main decoupling mechanisms have been proposed: total revenue cap and revenue-per-customer cap. In the revenue cap approach, the total revenue that is earned by the utilities is capped at the revenue requirement. In the revenue-per-customer cap approach, the revenue-per-customer is capped in such a way that the revenues from the entire customer base will be sufficient to meet the revenue requirement. In both methods, differences between the allowed revenue requirement and the actual revenues can be reconciled. Although decoupling assures the network company of its future cash streams flows, the relationship between prices for various services and the costs of providing those services is unclear. For instance, if the number of customers in a network’s service territory decreases during an economic recession, the revenue-per-customer must increase, if the aggregate revenue requirement is to be met. Thus, the price or charge for a service may become meaningless because it may not be a good indicator of costs incurred to provide that service.

### **2.1.3 Commercial Service Charges**

Network companies incur administrative costs for providing services to consumers such as billing, meter reading, and customer support that are independent of network operations. A network company can charge for commercial services in the form of a charge that is averaged over all customers irrespective of



the number of transactions or services provided to particular customers. Alternatively, it can charge fixed transaction fees that are unique to the type of transaction. It can further differentiate the charging mechanism by charging a minimum or fixed fee to all customers for essential transactions like meter reading and billing, and additional fees in the event that a customer is provided with other services. Commercial service charges can also be capped at a maximum during a billing cycle to ensure that consumers do not overpay for such services.

#### **2.1.4 Energy Policy Charges**

Some network-related costs are policy-driven. For instance, an electricity system could decide to cross-subsidize the costs of energy and delivery to low-income or rural communities. Such charges could be recovered from non-subsidized network users on a recurring basis.

Costs of energy policy that are not related to the network can be bundled with the network costs and passed through to the network tariff. Such charges can be recovered from some or all network users through an average charge that is recovered in a lump sum, periodically, or in a limited number of installments. For instance, charges for nuclear decommissioning or the stranded costs of restructuring can be recovered as a lump-sum fee or in installments until the associated costs are recovered. A system also has the choice of recovering such costs from the general population or economy, because the benefits of such policies are arguably realized not only network users, but others as well.

## **2.2 Tariff Types**

The network characteristics described above influence the charging mechanism or tariff structure used to recover the costs of delivering electricity to consumers. In restructured or deregulated electricity systems with wholesale electricity markets, energy is procured in the wholesale market by distributors or retailers on behalf of consumers. Distribution companies that procure energy in the market incur an expense for the energy procured, but no direct costs related to the generation of energy. As a result, the cost of energy procured can be passed through as an operating expense through the revenue requirement process and to the final consumer tariff. In fully deregulated systems, end-use customers can choose to purchase or negotiate with a competitive retail supplier for the *energy* component while continuing to receive *delivery* of electricity from the distribution network in whose service territory they are located. The cost of energy can be separated from the network-related cost of delivery in this way. This separation results in two types of tariffs:

- **Network or access tariffs** – network-related capital and operating costs
- **Integral tariffs** – cost of energy and network-related operating and capital costs

Thus,

$$\text{Integral tariffs} = \text{Network Tariffs} + \text{Cost of Energy}$$

Figure 1 depicts the relationship between network tariffs and integral tariffs.

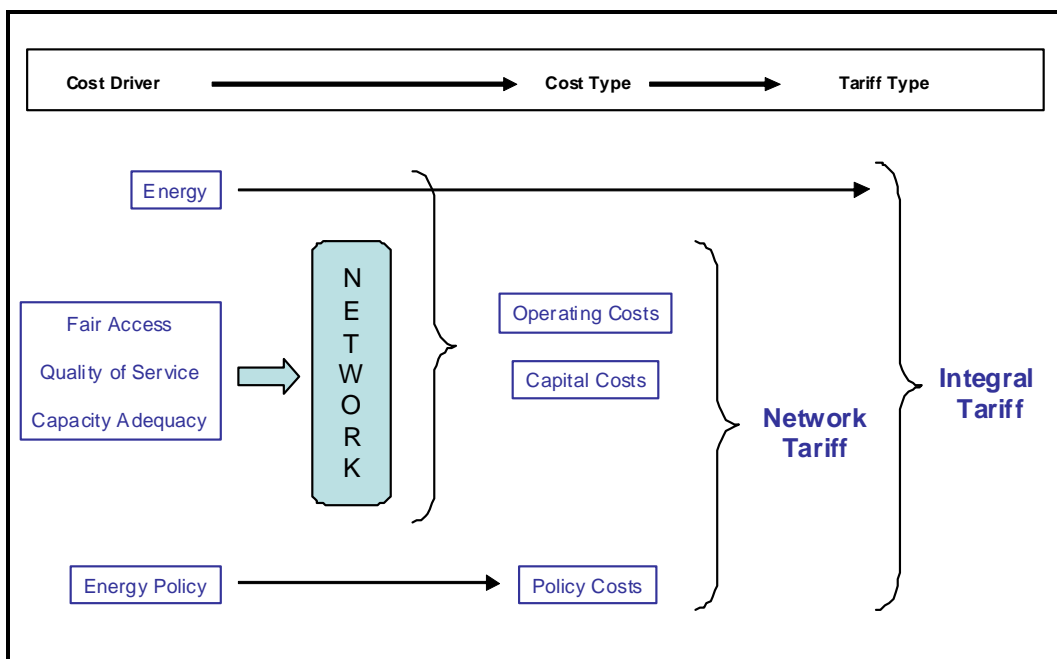

**Figure 1. Regulatory Drivers and Cost Categories influencing Tariff Types**

Integral tariffs are observed in systems that are still regulated or in the process of restructuring. In the case of fully regulated systems, customers pay an integral tariff that is approved by the regulatory agency. Customers do not have the ability to choose their energy supplier. In systems undergoing restructuring, customers have the option to switch to an energy provider that is different from their traditional utility, under certain conditions of eligibility. In such situations, they pay network tariffs to their distribution company, and energy costs to their energy supplier and this arrangement is referred to as competitive supply. However, they may still elect to obtain both energy and delivery from their distribution company. In such cases, the distribution company is said to provide default or basic service.

It must be noted that the distribution company is usually the billing agent for both competitive and default service. Where customers choose competitive supply, the distribution company charges customers on behalf of the supplier and subsequently remunerates the supplier. Some systems that have fully separated distribution from retail supply require the competitive supplier to be the billing agent. Irrespective of the tariff type used, the revenues received by the network company must be sufficient to meet its revenue requirement.

Since the cost of energy is passed through to the integral tariff in regulated environments and dealt with separately in competitive supply, the network tariff is the mechanism through which a network company recovers its costs related to transmission, distribution, ancillary services, administration, and commercial services.

## **2.3 Regulatory Drivers**

Regulatory drivers can be thought of as the high-level principles that influence the long-run decisions of the network owner. Given these high-level principles, certain aggregate decisions are forced; lower-level principles determine the disaggregated decisions. The main high-level principles affecting tariff design, directly or indirectly, are described here.

### **2.3.1 Universal Access**

A system may decide to require that all generators and end-use customers have access to the network. This is motivated by the possibility that, network companies could deny access to potential network users unless they are able to recover the costs of increasing capacity or operating networks in high-cost areas. For instance, consumers in rural or sparsely populated areas may not have access to a distribution network because of the capacity investments required. In some cases, generators that are not in close proximity to the transmission network or impose stricter reliability requirements on the network may be denied access to the network. Thus, networks can be regulated to ensure universal access with provisions for recovering access-related costs for the various types of network users such as generators, consumers, or adjacent networks.

### 2.3.2 Quality of Service

A system could provide varying levels of quality of service to different types of customers, and charge them accordingly. The quality of electricity delivery involves technical dimensions such as reliability and power quality, and other dimensions such as the quality of commercial services, described as follows (Fumagalli 2007):

- **reliability of supply**, i.e. the number and severity of the power supply interruptions to consumers
- **power or voltage quality**, i.e. the technical characteristics of electricity such as voltage dips, harmonics, or flicker, that may cause disturbances or negatively affect the proper operation of apparatus and equipment
- **quality of commercial services**, i.e. the quality of services like providing connections, billing, responding to outages, etc.

Reliability of supply and power quality are technical standards and in the domain of both transmission and distribution owners and operators. Commercial quality primarily involves relationships with customers and is therefore in the domain of distribution entities and retail suppliers in some cases. Delivery standards are essentially operating standards, and consequently affect the costs incurred by companies for the operation and maintenance of physical infrastructure, control centers, staff and dispatch crews, etc. In many cases, the quality of delivery and the corresponding costs can be differentiated for users such as large industrial users.

### 2.3.3 Capacity Adequacy

Transmission equipment such as lines, transformers, communication and protection devices, control mechanisms, etc are expensive and the cost of new investments is much higher than the recurring operating costs of the network. The expected useful life of transmission assets is also quite long, usually at least 40 years. Additionally, the availability of equipment in only a limited number of standardized capacity ratings for equipment makes it difficult to size new capacity additions to exactly match expected utilization, or to add capacity incrementally. As a result, new transmission investments occur infrequently and in large blocks. The regulation of transmission networks as natural monopolies implies that regulatory approval must be received before an investment is made. Transmission companies forecast the need for new transmission capacity based on economic and demographic information and propose expansion plans to the regulatory agency. When a proposal is approved and capacity is added, the capital costs are included in the revenue requirements of the network company. The investment costs and the

corresponding return on investments are subsequently recovered from network users through network charges (Kirschen and Strbac 2004).

### 2.3.4 Costs of Energy Policy

An electricity system may incur certain costs as a whole that are not related to the operation or expansion of networks, but are outcomes of regulatory decisions or energy policies. Such costs include moratoria or decommissioning of nuclear power plants and feed-in tariffs for renewable generation. In systems that have undergone restructuring or deregulation, stranded asset costs and the costs of transitioning to market-based systems may have been incurred. Additionally, some policies may involve energy and network costs such as the cross subsidization of low-income or extra-peninsular populations. An electricity system may choose to recover such energy policy costs from all network users by including the corresponding charges in the network tariffs. However, it could be argued that the benefits of such energy policies are accrued by the economy as a whole and that the cost of energy policies should be recovered from the entire population, not just electricity network users.

## 3. ISSUES RELATED TO TARIFF STRUCTURE

### 3.1 Choice of Principles

In light of all the choices available to an electricity system while designing the tariff structure, a number of economic or regulatory principles can be used as a guide, based on the goals of the system.

#### **System Sustainability Principles:**

Principles that are essential for the successful functioning of networks

***Universal access*** - electricity is an essential service to which all consumers should be entitled

***Complete cost recovery*** – all accredited system costs must be recovered for the system to be financially viable

***Additivity of components*** – various tariff components must add up to give the total revenue requirement to be recovered

### **Economic Efficiency Principles:**

Principles that minimize economic losses and ensure an efficient system

**Productive efficiency** – network services should be delivered to consumers at the lowest possible cost

**Allocative efficiency** – consumers should be charged in accordance with how much they value the network services provided

**Equity** – all consumers that belong to a certain category and demand the same network services should be charged the same, irrespective of the end-use of electricity

### **Consumer Protection Principles:**

Principles that safeguard the interests of consumers

**Transparency** – the methodology and results of tariff allocations should be published and available to network participants

**Simplicity** – the methodology and results of the tariff allocations should be easy to understand

**Stability** – the tariff structure should result in stable electricity prices in the short-term, with gradual changes in the long-term

Although regulatory institutions believe that these principles should influence the design of tariffs, they may not choose to implement each and every one of them. In fact, the inherent conflict between some principles makes it infeasible for their simultaneous implementation. For instance, it is reasonable to expect that tariffs that are productively and allocatively efficient are so complex in design that they are not consistent with the principle of simplicity. A good example of this is network charges obtained from a complex reference network model that is difficult to understand by any who are not familiar with the modeling techniques. Thus, a system that desires simplicity will also have to bear the inefficiencies associated with a tariff structure that ignores economic principles. Similarly, a system may consciously choose not to adopt a principle such as equity so that certain low-income customers can be protected. In other words, low-income customers could have a low tariff even though they impose a cost of delivery identical or similar to high-income customers. In this case, tariffs may not be fully efficient but could still satisfy other system requirements such as universal access and complete cost recovery. The choice of regulatory principles thus implies a variety of trade-offs in the design of tariff structures.

### **3.2 Siting of Generation**

The choice of the provisions for connection charges in a system can influence the siting of generation, if generators are required to pay connection charges. The direct connection and reinforcement costs for a certain location in the network could be much higher than those for another location in the network. For instance, connecting wind generation from a location with abundant wind resources far from an existing network may be extremely expensive, and the generator might choose a different location with similar wind resources or a different generation source like a natural gas plant in order to be located closer to the network and thus reduce connection costs. If generators are responsible for a large fraction of this cost or the total cost, they may choose a generation technology other than wind. Connection charges for generators could therefore be structured to influence the siting of generation.

If generators are not required to pay connection charges, either shallow or deep, the costs will be borne by the rest of the network users, viz. customers, thereby increasing customer tariffs. Moreover, generators will not have any incentives to choose a connection point that will minimize connection costs, which is inconsistent with the principle of productive efficiency. This structure is also inconsistent with the principle of allocative efficiency, that is, the costs for a shared network should be borne by all network users in proportion to the value they place on network services. At the very least, generators could be charged a shallow connection charge as an incentive to optimize their location with respect to the network.

### **3.3 Selection and Scale of Generation Technology**

The issue of technology selection arises out of the provisions for Use-of-System charges for generators in an electricity system and the extent of network capacity additions and reinforcements required for a particular generation technology. As described above, in cases where the cost of network reinforcements is fully allocated to consumers through UoS charges, it has not been recovered through deep connection charges to generators. For an intermittent generation source like wind, more sophisticated and expensive reinforcements might be required to ensure the system's quality of service. In such situations, UoS charges for consumers increase. Additionally, generators may not have an incentive to reduce the cost of reinforcements in the absence of UoS charges to them.

In the case of generation connected at low voltage distribution levels or *distributed generation*, generators are located close to consumers and may sometimes offset the use of the higher voltage levels of the network. As a result, they could be charged less for network usage and reinforcements at higher voltage levels and more for increased low voltage level usage.

It is believed that certain levels of distributed generation may in fact decrease the need for reinforcements or network capacity at higher voltage levels, thereby benefiting all network users (Cossent et al 2009). However, distributed generation that uses intermittent sources such as wind or solar energy may continue to require adequate network capacity to deliver back up electricity to those network areas. In such cases, the cost of reinforcements or network capacity is not avoided. The benefit and cost contributions of such generators cannot be factored in to the UoS charges through a simple postage stamping mechanism. A reference network model could be used to approximate the charges to be allocated to individual network users in networks with distributed generation.

Tariffs involving gross- or net-metering mechanisms that are reflective of network use could also be implemented. If net-metering is chosen, it is not feasible to apply differentiated tariffs to electricity withdrawn and supplied to the network. As a result, a distributed generator may receive the retail rate for the electricity supplied to the network, even though the rate includes charges for costs incurred at higher voltage levels. By off-setting the use of the higher voltage levels, it could be argued that the compensation rate should correspondingly decrease. This issue could be avoided through gross-metering, if network usage (or usage offsets) are appropriately taken into account while setting the compensation rate. Again, a reference network model could be employed, but the complexity of the differentiated tariffs must also be acknowledged.

### **3.4 Maintaining Quality of Service**

The principle of complete cost recovery along with quality of service requirements may influence the magnitude of UoS charges. Network companies incur certain operating costs in network maintenance, procuring ancillary services, etc to provide a certain quality of service to network users, which are subsequently recovered through UoS charges. In the absence of specifications or incentives for maintaining a desired quality of service, network companies could avoid such costs to maximize the profit they can earn if they are allowed to recover their revenue requirements. Additionally, expenses for maintaining quality of service may not be efficient, resulting in UoS charges that are higher than necessary. To ensure a desired quality of service with reasonable UoS charges, a number of regulatory instruments could be used:

- **Data Publication:** By publishing statistics related to network company performance, a system can provide consumers information about network company operations. Publicizing such information may provide companies with an incentive to improve performance.
- **Performance Standards:** An electricity system could specify minimum quality standards for performance accompanied by financial penalties for non-compliance. This instrument acts as an



incentive for companies to make expenses that will result in the desired minimum quality of service. Performance standards accompanied by financial penalties for non-compliance and financial rewards for improvements can provide incentives to ensure that the quality of service is provided efficiently. For instance, network companies may be rewarded if they can provide the desired quality of service by minimizing the costs incurred in doing so.

- **Premium Quality Contracts:** A system could allow bilateral contracts between network companies and certain consumers who place a higher value on quality of service than other consumers. For instance, a large customer such as a manufacturing company may be willing to pay a premium for a guaranteed quality of service. By allowing such customers to enter into a separate contract with the company, the costs for enhanced quality of service do not have to be recovered from other network users. Thus, customers pay UoS charges that are reflective of their desired quality of service.

The first two instruments inherently require the regulator to assess how consumers value the quality of delivery. On the other hand, quality contracts can be negotiated directly by network companies and consumers based on their preferences (Fumagalli et al 2007).

### 3.5 Ensuring Adequacy of Capacity

Network users pay for new network capacity investments through UoS charges. The long-term objective in transmission and distribution planning is to ensure that adequate capacity exists to meet the expected future demand for electricity at desired levels of reliability and quality.

In most cases, the network owner and operator is responsible for planning and new investments. However, some systems have separated the long-term function of regional transmission planning and investment from the short-term operation and maintenance of networks to ensure that network investments are made prudently. Independent System Operators (ISOs), Regional Transmission Organizations (RTOs) or regulatory agencies may perform this role. Some electricity systems allow for unregulated companies other than the monopoly transmission network company to propose and build transmission capacity, known as merchant transmission. The merchant investor provides the capital for such investments, which it expects to recover through operating revenues.

The decisions to invest in new infrastructure are partly related to any prescribed performance standards, as discussed above. But more importantly, new capital investment decisions depend on current capacity planning that is based on expectations of future demand. Furthermore, the rate of return on investments also influences the investment decision. If the rate is too low, the network company does not have an

incentive to invest, leading to an inadequacy of capacity, congestion and higher delivery prices. A high rate of return may result in overinvestment, where capacity could be underutilized. Thus, expansion of network infrastructure and investments should be made carefully to ensure that network users do not overpay for inadequate or underutilized capacity.

### **3.6 Cross-subsidization of Tariffs**

The issue of cross-subsidization arises under the principle of universal access when certain categories of customers are charged lower tariffs than other customers for similar network services. For example, a low income customer in a particular service area may be charged a low tariff compared to a high income customer in the same area. Some of the costs of delivery to the low-income customers are thus borne by other customers to ensure that all customers have access to electricity.

The cost of delivery for a certain category of customers may be much higher than other customers as in the case of rural populations, or countries with large geographical distances between generation and load centers. In such electricity systems, postage-stamp tariffs based on the principle of equity would result in a higher average UoS charges for consumers in relatively low cost areas, thereby subsidizing the customers in high cost areas. Such a tariff structure is inconsistent with the principle of allocative efficiency, but could be deemed fair across the population as a whole.

### **3.7 Incidence of Energy Policy Costs**

The recovery of energy policy costs such as stranded costs of restructuring or nuclear moratoria in network tariffs may be essential for overall electricity system sustainability. However, an electricity system is not faced with the issue of cost allocation with regard to these costs because they are not incurred while providing network services to particular users. In some systems, the high costs of energy from renewable sources is subsidized due to the policy goal of reducing greenhouse gas emissions and reducing reliance on fuel sources such as coal or gas. The benefits of reduced emissions and fuel diversity are accrued by the entire population. Once again, calculating the marginal benefit accrued and the marginal costs to certain users is unfeasible as in the case of some network related issues. But a system could decide to recover such policy related costs from the population as a whole instead of captive electricity network users only.

Having discussed the various issues that influence tariff designs, we now examine the designs in four different electricity systems: Australia, New England (USA), Portugal and Spain. The country studies

illustrate a variety of choices in the context of natural monopoly regulation, the shared nature of networks and the provision of incentives to network users through tariff designs.

---

## **PART II : COUNTRY STUDIES**

---

### **NEW ENGLAND (USA)**

End-use customers in New England pay network tariffs that are clearly delineated in terms of their components such as network related costs and energy policy costs. The delineation allows customers to gain an understanding of the cost of delivering network services, in comparison with energy policy costs. Energy policy costs are a small fraction of network tariffs, and therefore do not significantly distort the cost reflectiveness of network tariffs. A single tariff design is applied to all transmission networks, irrespective of physical and ownership characteristics, which results in fixed transmission tariff rates across the New England system. Distribution network tariffs vary by state and have a moderate degree of differentiation by voltage level and time of use, but are similar in structure across the distribution utilities. Some distribution networks calculate network tariff rates for specific zones within their service areas, which allows customers in each zone to bear the cost of delivering electricity in that zone. A high degree of geographical differentiation in network tariffs is more cost reflective than an average rate across the utilities' entire service area. Distributed generators in New England receive a subsidy because they are paid for network use while supplying net-metered electricity back to the grid, through a retail rate that includes network tariff components.

#### **1. SYSTEM CHARACTERISTICS**

The New England region, comprised of six relatively small states in the northeastern United States, is served by a single interconnected electricity system. Although each of the states have separate structures for network ownership and regulation, the states' small size and geographical proximity facilitates the operation of the system by a single independent system operator (ISO). The ISO model has implications for the market and network organization of the six states, and also influences the network tariffs in the region.

Independent System Operator-New England (ISO-NE) is an independent, not-for-profit corporation that oversees the wholesale power generation and transmission system in the New England area. It also manages wholesale market operations and system-wide planning. ISO-NE was formed in 1997 to serve the six states of Connecticut, Maine, Massachusetts, New Hampshire, Rhode Island and Vermont. Figure 1 depicts the ISO-NE region sub-divided primarily along state lines. The sub-regions serve as market zones for the wholesale electricity market and network operated by ISO-NE. The state of Massachusetts (MA) is further sub-divided into three regions, Western-Central MA, Northern MA and Southern MA, due to its high population density.

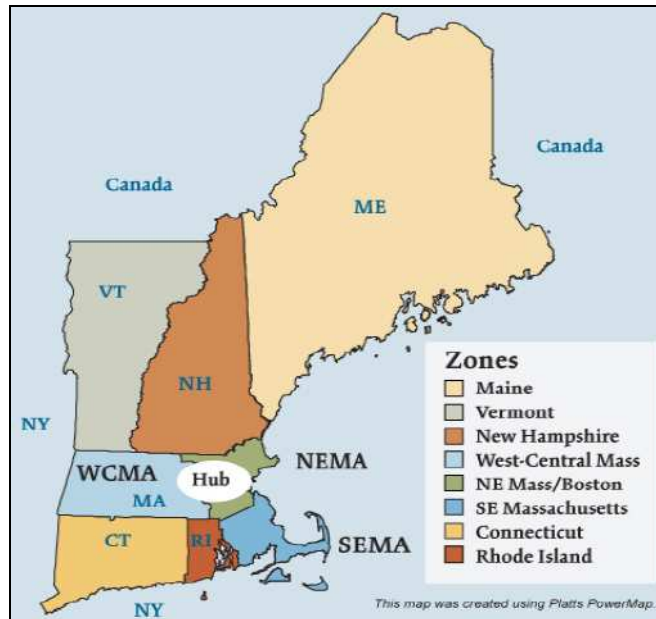

**Figure 1. Independent System Operator-New England (ISO-NE) Region**

Source: Federal Energy Regulatory Commission (FERC) 2008

## 1.1 Generation

Although ISO-NE operates the bulk power system and wholesale-market, it does not own any generation capacity. Generation is owned by independent power producers (IPPs) (or merchant generators), municipal utilities, and distributed generators. More than 350 generating resources supply electricity to the system, including natural gas and oil-fired power plants, hydroelectric dams, coal and nuclear stations, biomass plants, etc. Table 1 summarizes the characteristics of the power generation fleet in the ISO-NE region.

Generation in ISO-NE operates under the framework of a wholesale electricity market. Bilateral contracts between generators and customers are permitted, with any imbalances purchased in the spot market. The market is therefore a net pool. The spot market has day-ahead and real-time segments. Transactions are based on Locational Marginal Pricing (LMP), a wholesale pricing mechanism that reflects the costs of energy, congestion and transmission losses specific to particular locations in the network. ISO-NE procures ancillary services such as peaking reserve capacity and frequency and regulation through parallel ancillary services markets. Payments to ancillary services providers are made through monthly and annual settlement processes.

As shown in Table 1, over 40% of the capacity is natural gas, which is also the marginal fuel type. That is, the market clearing price is usually the price received by the last natural gas plant to be dispatched. Most generators that participate in the market are independent power producers, with over 80% of the generating capacity. Many traditional municipal utility generators with small generating capacities also supply to the market. About half of these are utilities with hydroelectric capacity located in the state of Vermont. The remaining utilities and CHP producers do not supply to the market, and generate electricity for their own use. The total market capacity available is therefore approximately 33,000 MW. No significant additions to generating capacity have been realized in recent years. Capacity additions have been incremental and typically augmentations of existing plants.

**Table 1. Generation Sector Profile in ISO-NE**

Data Source: ISO-NE, EIA (2009)

Energy Source	Number of Producers	Nameplate Capacity (MW)	Percentage Capacity
Coal	11	3,052	8%
Hydroelectric	188	1,859	5%
Natural Gas	60	14,948	42%
Nuclear	4	4,638	13%
Petroleum	89	8,176	23%
Renewables	37	3,315	9%
<b>Total</b>	<b>389</b>	<b>35,988</b>	<b>100%</b>
Independent Power Producers (IPPs)	233	30,044	84%
Utility Generators	82	2,638	7%
Combined Heat & Power (CHP)	74	3,307	9%
<b>Total</b>	<b>389</b>	<b>35,988</b>	<b>100%</b>

A forward capacity market (FCM) was initiated in 2008 to ensure an adequate supply of electricity in the short- to medium-term. The demand is projected three years in advance, and annual auctions are held to purchase the necessary supply commitments from generators. The FCM also has provisions for the participation of demand-side resources, where customers can compete with generators to offer demand reductions in lieu of securing additional generation capacity. Payments are made to such customers for reducing their electricity demand. ISO-NE estimates that 2000 MW of demand-side resources are available in the capacity market.

The existence of a wholesale market that is separate from network-related operations and services allows for a distinction to be made between energy and network tariffs. It also enables the existence of a retail

supply sector. The main implication for tariffs is architectural, i.e. the tariff design is comprised of separate charges for energy and network services.

## 1.2 Networks

ISO-NE only operates the transmission-level network in the New England region; it does not own any network assets. Networks are owned by separate companies, some of which own both transmission and distribution assets. A transmission company may own networks that extend beyond state lines and transactions are therefore subject to federal regulation by FERC. Similarly, companies may own distribution networks in more than one state, but the assets are regulated at the state level by state utility commissions.

The transmission networks in New England are primarily owned by seven network companies. These companies constitute approximately 98% of the network capacity in the region. The rest of the transmission networks are owned by small municipal utilities and electric power cooperatives. The network characteristics of the seven main companies are summarized in Table 2.

**Table 2. Network Company Characteristics in ISO-NE (2008)**

Data Source: ISO-NE (2009)

Network	Location (state)	Ownership	Average Network Load (monthly, MW)	Regulatory Structure	Asset Base (\$ millions)	Annual Revenue Requirements (\$ millions)
Bangor HydroElectric (BHE)	ME	Investor-owned	252	Rate-of-return	138.0	30.3
Central Maine Power (CMP)	ME	Investor-owned	1,418	Rate-of-return	142.3	46.7
National Grid	MA, NH, RI	Investor-owned	5,772	Rate-of-return	560.0	199.5
Northeast Utilities (NU)	CT, MA, NH	Investor-owned	7,173	Rate-of-return	2,231.5	553.5
NSTAR	MA, NH, RI	Investor-owned	4,183	Rate-of-return	541.4	163.6
United Illuminating (UIL)	CT, MA, NH	Investor-owned	716	Rate-of-return	395.0	121.4
Vermont Transmission Company (VTransCo)	VT	Public	852	Rate-of-return	281.2	85.5
<b>Total</b>			<b>20,366</b>		<b>4,289</b>	<b>1,201</b>

Six of the companies are investor owned utilities, while VTransCo is owned by a consortium of municipalities. All the network companies are regulated through a rate-of-return mechanism, where the companies recover their annual revenue requirements (ARR) plus a reasonable rate of return on investments. ISO-NE is responsible for calculating the network tariffs for each network company in the region. The network companies are regulated by the Federal Energy Regulatory Commission.

Figure 2 displays the geographical distribution of these networks in the New England Region. The network companies' regulated asset base (RAB) as a share of the total RAB for the companies are used to gain an understanding of the size and concentration of the networks. The networks are most dense in the states of Connecticut (CT), Massachusetts (MA), New Hampshire (NH), and Rhode Island (RI). Northeast Utilities (52%) is the largest transmission network in terms of RAB, followed by National Grid and NSTAR. The companies in Maine are much smaller. Vermont Transmission Company (VTransCo) owns the entire transmission network in Vermont (VT) and contributes to approximately 7 % of the total ARR for the networks in the region. The relative size and density of the networks is an indicator of the residential, commercial and industrial demographics of the states.

The total length of transmission lines in the region is approximately 8,000 miles. In addition to networks, there are twelve transmission interconnections to the networks in the adjacent New York ISO and Eastern Canadian provinces. Of these, the Cross Sound Cable is a merchant transmission line running between Connecticut and Long Island in New York, and is owned by a private holding company. The 24-mile long HVDC submarine cable can provide up to 330 MW of transmission capacity.

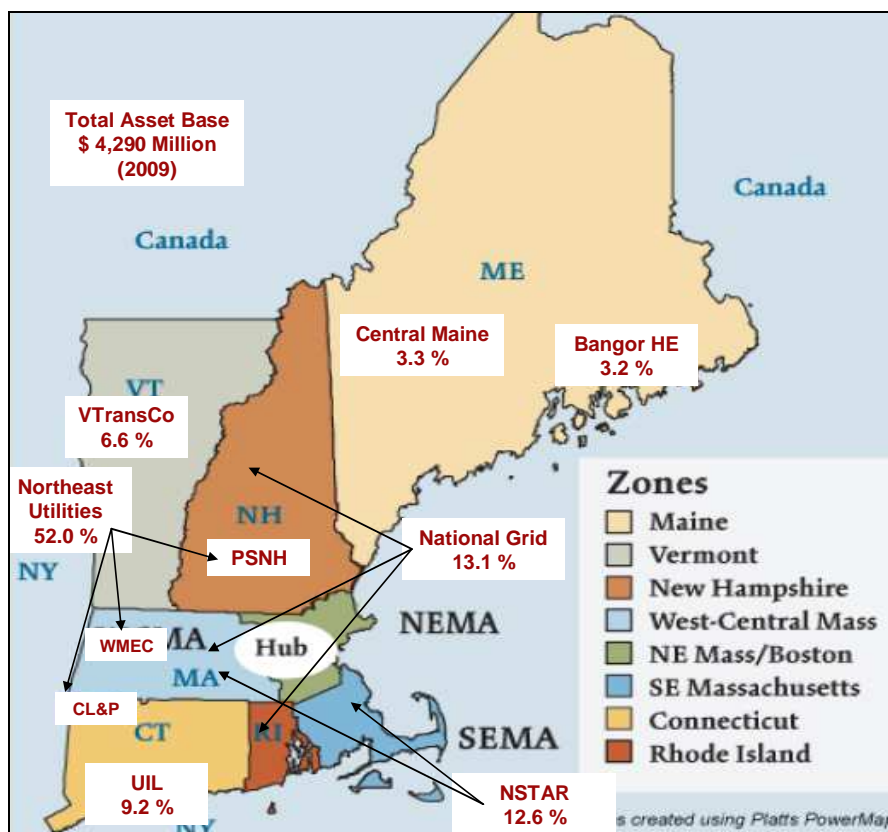

Figure 2. Concentration of Transmission Networks in New England by ARR (2006)

Data Source: ISO-NE Rate Setting Data (2006)



New transmission investments in the New England system that are not new generator interconnections are primarily of three types:

- Reliability upgrades – investments to preserve or enhance the reliability of the system as a whole that is proposed as a consequence of a system-wide reliability study
- Market efficiency upgrades – investments designed to reduce bulk system-wide costs where the net present value of the reduction in system costs exceeds the net present value of the transmission investment
- Elective upgrades – a voluntary investment that a generator or network owner may undertake for operation as a merchant facility or other reasons

The ISO rules provide due processes for each type of investment which include requirements for applications and permits, system impact studies, project design and standards, and cost allocation. In the first two cases, investments are added to the rate base of the relevant network company and subsequently recovered through the annual revenue requirements of the company. These charges are passed through to customers through the network tariffs. Any entity proposing an elective upgrade is responsible for a 100% of the costs of the upgrade, and is not permitted to pass this through to the annual revenue requirements of any network in the system. Thus, procedures for investing in new transmission are available and employed in the ISO-NE system, with provisions for allocation and recovery of investments from network users. However, these costs are incurred and recovered only after the new investments are approved. Decisions regarding the necessity and prudence of reliability or market efficiency upgrades are therefore a separate issue. Such decisions are ultimately made by the state utility commissions in whose jurisdictions the investments will occur, and under FERC oversight where applicable.

## **2. TARIFFS**

The design of network tariffs in the ISO-NE region has two important characteristics. Firstly, ISO-NE applies one tariff design at the transmission level to the networks of all transmission owners in the New England Power Pool and transmission-level network users. Secondly, at the distribution level, similar network tariff designs are employed by the different states, with some provisions to reflect the unique characteristics of the respective states. In all cases, the network tariffs are clearly and transparently passed through to the final customer, as observed from the rate structure.

## 2.1 General Tariff Design

Table 4 summarizes the general network tariff design in the ISO-NE region, inclusive of transmission and distribution.

**Table 4. Network Tariff Design in New England**

Data Source: ISO-NE, State commissions

<b>Independent System Operator-New England</b>				
	<b>Cost Components</b>	<b>Customer Type (by consumption)</b>	<b>Cost Allocation</b>	<b>Rate Structure</b>
<b>Connection Charges</b>	Connection assets; Network reinforcement	Generator	Dedicated (deep)	
		Large	Dedicated	Fixed monthly (\$/month)
		Medium	Dedicated	Fixed monthly (\$/month)
		Small	Shallow; average	Fixed monthly (\$/month)
		Distributed Generator	Dedicated	Fixed monthly (\$/month)
<b>Distribution UoS Charges</b>	Shared network use; Common services like system control; Administrative costs of network operation	Large	Zonal, average by voltage category	Monthly demand (\$/kW/month) or (\$/kVA/month) and volume (\$/kWh)
		Medium	Zonal, average by voltage category	Monthly demand (\$/kW/month) or (\$/kVA/month) and volume (\$/kWh)
		Small	Zonal, average by voltage category	Volume (\$/kWh)
		Distributed Generator	Zonal, average by voltage category	Only if consuming; by size as above
<b>Transmission UoS Charges</b>	Shared network use; Common services like ancillary services; Administrative costs of network operation	Large	Postage stamp	Monthly capacity (\$/kW/month)
		Medium	Postage stamp	Monthly capacity (\$/kW/month)
		Generator	Postage stamp	Monthly capacity (\$/kW/month)
<b>Commercial Services</b>	Meter installations and reading; billing services	All	Zonal average	Fixed monthly (\$/month)
<b>Energy Policy</b>	Renewable Energy	All	System-wide surcharge	Volume (\$/kWh)
	Restructuring	All	Average by voltage category and customer type	Volume (\$/kWh)

Connection charges in the ISO-NE differ by customer category, and vary from “shallow charges,” “deep” charges,” and intermediate charges. Generators connected to the transmission network are usually responsible for a hundred percent of the direct connection costs, plus at least 50% of the network reinforcements depending on the nature of the interconnection and necessary upgrades. Distributed generators are charged deep connection costs; they pay for direct connection costs on-site as well as network reinforcements in the distribution system. End-use customers such as small residential and commercial customers pay shallow charges for line extensions, with the cost of network reinforcements averaged across all customers at the respective voltage level. Large end-use customers generally pay

shallow charges for connection to the transmission or higher-voltage distribution network unless any network reinforcements are solely for their benefit, and will not be used by other customers at that voltage level. The design of connection charges primarily affects the siting decisions of generators and customers. However, most network users in the New England region are located very close to existing networks because of the dense population and relatively small geographical distances. Decisions regarding the capacity and type of distributed generation will be affected, because such generators are responsible for deep connection charges.

Distribution use-of-system charges are calculated by network zones, whereby customers are responsible for the average network costs in their zone. For instance, the network rates for customers in different parts of the Boston metropolitan area differ by the zone in which they are located. Small residential and commercial customers are charged by the volume of electricity consumed (\$/kWh). Large commercial customers are charged by both maximum monthly demand (\$/kW/month or \$/kVa/month) and volume consumed (\$/kWh). Distributed generators are responsible for the network charges applicable to their network zone and customer type for the portion of electricity consumed from the distribution network. Thus, they are treated as typical distribution-level customers when they draw electricity from the network.

Transmission use-of-system charges are identical in design across the entire ISO-NE system. A postage stamp rate is calculated for all transmission level network users in the form a capacity charge (\$/kW). Transmission-level tariffs are billed monthly and reconciled annually. The postage-stamp rate does not allow for a reflection of the cost of network services at the transmission level by location. However, the locational marginal pricing mechanism in the energy market serves this purpose partially, as it includes congestion costs in the energy price at each load zone in the system. Thus, siting decisions for generators and customers will be influenced in part by the LMP.

Charges for commercial services such as meter reading, billing and other administrative expenses are recovered through a fixed monthly charge (\$/month). These costs are added to the fixed monthly connection charge.

An energy policy charge such as the cost of procuring renewable energy to meet Renewable Portfolio Standards is identical for all customers where applicable and recovered as a surcharge, as in the state of Massachusetts. The renewable energy charge is calculated and revised semi-annually and levied by consumption volume (\$/kWh). Costs pertaining to restructuring and recovery of stranded asset costs in both transmission and distribution are calculated as an average by voltage category and customer type, also charged by consumption volume (\$/kWh).

The separation of charges for network-related costs from energy costs allows a good understanding of the costs of network ownership and operation and the allocation of these costs to different types of network users. Energy policy charges are passed through to all end-use customers.

## 2.2 Transmission Network Tariffs

As the system operator for the region, ISO-NE is responsible for calculating, allocating and billing transmission-level network tariffs, based on information supplied by the respective networks. ISO-NE performs these functions in accordance with the Open Access Transmission Tariff (OATT), a set of regulations and guidelines governing the network and market operations for the New England system which are approved by the FERC. The OATT is enabled by a series of legally-binding agreements between the ISO and the network companies that comprise the New England Power Pool. The ISO calculates and reports the annual revenue requirements for each network to the Federal Energy Regulatory Commission, because the network ownership and market transactions are not always within state boundaries. As such, the regulation of transmission network tariffs is ultimately subject to federal oversight.

**Table 5. Postage-stamped Regional Network Services Tariff for 2009**

Data Source: ISO-NE (2009)

RNS PTO	Adjusted Pre1997 RNS Rate	Post-1996 RNS Rate	RNS Rates for		Delta
	EE	W'	June 1, 2009 FF	RNS Rates previously in effect December 1, 2008	
-----\$ / kW-yr.-----					
NSTAR	14.29199	45.65502	59.94700	43.84661	16.10039
BH	14.29199	45.65502	59.94700	43.84661	16.10039
FGE	14.29199	45.65502	59.94700	43.84661	16.10039
CMP	14.29199	45.65502	59.94700	43.84661	16.10039
NGRID	14.29199	45.65502	59.94700	43.84661	16.10039
NU	14.29199	45.65502	59.94700	43.84661	16.10039
UI	14.29199	45.65502	59.94700	43.84661	16.10039
VTRANSCO	14.29199	45.65502	59.94700	43.84661	16.10039
Pool PTF	14.29199	45.65502	59.94700	43.84661	16.10039

**Legend:**

PTF - Pool Transmission Facility

Pre 1997 - before restructuring

PTO - Pool Transmission Operator

Post 1996 - after restructuring

RNS - Regional Network Service

**Table 6. Postage-stamped Through or Out Services Tariff for 2009**

Data Source: ISO-NE (2009)

Export over the Pool Transmission Facilities to	TOUT Service Rates (\$/MW-hr.)
HydroQuebec (Canada)	\$6.8432
New Brunswick (Canada)	\$6.8432
New York	\$0.0000

Transmission network tariffs are postage stamped for Regional Network Services (RNS), i.e. all network services provided within the pool transmission facilities in the New England control region. Based on the different annual revenue requirements for each transmission network, ISO-NE calculates a single RNS tariff that is levied on transmission network users in the form of a \$/kW/year charge. The total payments collected for RNS serves are re-distributed to the network companies in accordance with their ARR in an annual settlement process. The RNS tariff does not include charges for local services that are provided within the networks of individual companies outside the pool transmission facilities. Table 5 depicts a calculation for the RNS tariff for the year 2009.

Some services known as Through or Out services (TOU) are provided to network users that are located outside the New England control region. An example of a TOU service is a energy supplied to a network user in an interconnecting region such as Canada or New York, which originates or passes through the New England network. Charges for such services are recovered through a separate TOU tariff (also postage-stamped) that is levied only on customers availing of such services. The TOU tariff for 2009 is listed in Table 6.

ISO-NE also recovers charges from network customers for common services such as scheduling, dispatch and control services and other ancillary services which it then pays to parties providing such services. Administrative costs for the operation and management of the ISO are also recovered through annual charges.

Figure 3 depicts the financial flows at the transmission level across the ISO-NE system for a single year, with the ISO as the billing agent. Various network services are accounted for as separate components of the charges to customers. The total sum collected is then redistributed to networks and ancillary service providers, less revenues to ISO-NE. The flows do not include energy-related transactions which are managed through a separate market settlement process between generators and customers, with ISO-NE again serving as a billing agent. Network usage accounts for 73% of total payments, with 99% of usage revenues for Regional Network Service. Ancillary services payments constitute roughly 10%. About 14% is retained by ISO-NE for to cover its operating and administrative expenses.

Transmission network tariffs are passed through to end-use customers, as observed in the final network rates. Although some network companies such as NSTAR and National Grid own both transmission and distribution assets, tariffs for each network type are calculated and charged separately.

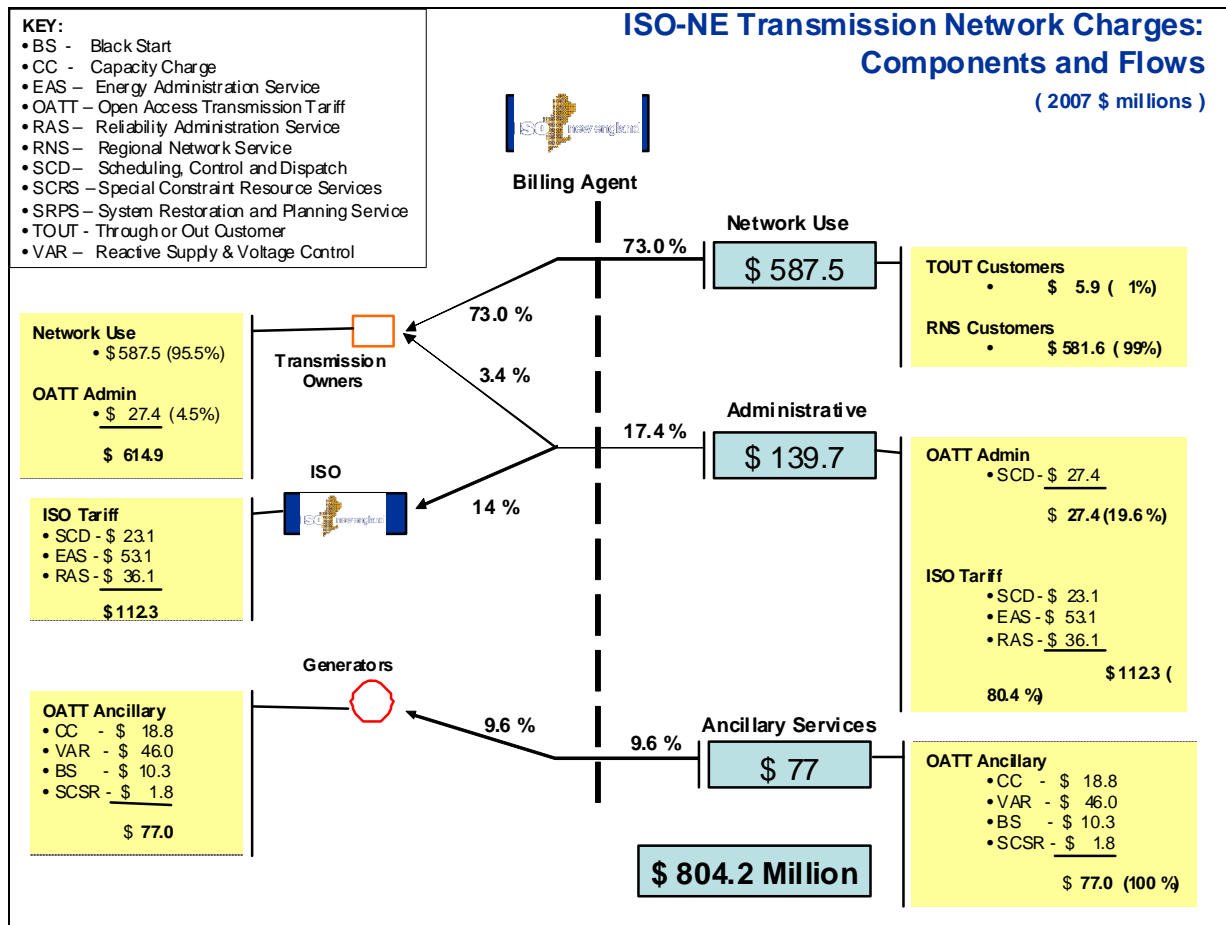

Figure 3. ISO-NE Transmission Financial Flows (2007)

Data Source: ISO-NE (2009)

## 2.3 Distribution Network Tariffs

Each state in the New England region has different distribution network companies operating as investor-owned utilities or municipal utilities. Consequently, the distribution network tariffs vary by state, and by the network characteristics of each utility. The network tariffs are approved by the state utility commissions for the respective states.

The tariff design for NSTAR, a large investor-owned utility in the state of Massachusetts, is representative of the designs in the region and is therefore used for the purpose of this analysis. NSTAR owns both transmission and distribution assets, and its tariffs are approved by the Massachusetts Department of Public Utilities. NSTAR primarily provides network services to end-use customers in the Massachusetts

region. It procures energy on behalf of customers and supplies it to customers as a retail supplier. Selected network rates for some of NSTAR's customer categories are shown in Table 7. These charges are applicable to a single zone within NSTAR's service area and are therefore unique to that zone. Charges are itemized separately as connection, transmission, distribution, and energy policy charges and appear in a customer's monthly bill in a similar format.

**Table 7. Network Tariffs for NSTAR Customers in the Cambridge Zone (2009)**

Data Source: NSTAR (2009)

Tariff	Network				Energy Policy			
	Fixed (\$/month)	Transmission (c/kWh)		Distribution (c/kWh)		Transition (c/kWh)	Energy Conservation (c/kWh)	Renewable Energy (c/kWh)
<b>Fixed Rate</b>								
General Residential (R-1)	6.87	1.48		3.71		(0.56)	0.25	0.05
Residential Heating (R-3)	7.77	1.74		4.36		(0.56)	0.25	0.05
Residential Assistance (R-2)	1.03	1.48		0.56		(0.56)	0.25	0.05
General Business (G-0) (Load < 10 kW/month)	4.62	1.38		3.30		(0.56)	0.25	0.05
<b>Differentiated by Time-of-Use</b>								
		Peak	Off-peak	Peak	Off-peak			
Residential Time-of-Use	10.47	3.32	0.00	10.09	1.90	0.55	0.25	0.05
Business Time-of-Use (G-6)	8.22	4.69	0.00	6.28	2.27	0.56	0.25	0.05
<b>Differentiated by Demand</b>								
	(\$/month)	Demand (\$/kW)	Energy (c/kWh)	Demand (\$/kW)	Energy (c/kWh)	(\$/kW)	(c/kWh)	(c/kWh)
General Business (G-1) (Load < 10 kW/month)	7.32	3.32	0.00	3.76 (first 10 kW) 7.01 (over 10 kW)	1.07	(1.68)	0.25	0.05
Business Time-of-Use (G-4) (10 kW < Load < 100 kW/month)	10.92	4.03	0.00	4.16 (during peak)	0.98	(2.36)	0.25	0.05
	(\$/month)	(\$/kVA)	(c/kWh)	(\$/kVA)	(c/kWh)	(\$/kVA)	(c/kWh)	(c/kWh)
Large Business (G-2)	90.00	2.84 (first 100 kVA) 5.83 (over 100 kVA)	0.00	4.06 (first 100 kVA) 5.03 (over 100 kVA)	0.89	\$1.27 /kVa & \$(0.87) /kWh	0.25	0.05

Transmission charges are those passed through to distribution networks as transmission customers procuring Regional Network Service. They are averaged across voltage categories in the particular zone

in the form of a volume-based charge for small customers (\$/kWh), and a demand- (\$/kW or \$/kVA) and volume-based charge (\$/kWh) for large customers.

Distribution charges are similar in structure to the transmission charges. Small customers pay a monthly connection charge and a volume-based charge (\$/kWh). Large customers pay the appropriate demand-based charges (\$/kW or \$/kVA) in addition to the volume-based charge. Customers can select a time-of-use tariff with differentiated charges for peak and off-peak periods. The monthly connection charge includes connection costs as well as charges for commercial and administrative services.

Some customer groups such as low-income households and senior citizens can avail themselves of a special tariff category called the Residential Assistance tariff, which offers discounted connection and distribution-related charges. The access and network service costs to such consumer groups are therefore subsidized by other distribution customers.

All customers connected to NSTAR's network are responsible for certain types of energy policy charges. Transition charges are included to recover the stranded costs and administrative costs originating in the process of restructuring. Such charges are volume-based in the case of small customers and demand-based in the case of large customers. The charges are calculated as an average across each voltage category. In NSTAR's case, consumers receive a credit to reflect payments being made to NSTAR. Energy conservation charges are designed to support NSTAR's energy efficiency programs, while renewable energy charges recover the costs of procuring electricity from renewable energy sources such as paying for Renewable Energy Credits and payments to net-metered distributed generators. Conservation and renewable energy charges are identical across all distribution customers.

Distributed generators are responsible for net-metered payments, in addition to dedicated or deep connection costs. That is, when such customers consume more electricity than they generate, they are charged for the net electricity consumed according to the appropriate customer category. On the other hand, they receive payments when they supply surplus electricity back to the distribution network. The retail rate used is calculated as the sum of the energy, transmission, distribution, transition and energy policy components. Thus, distribution users pay for network use when they draw electricity from the grid, but receive payments for network use when they supply to the grid. This subsidy is available to all renewable distributed generation technologies including solar, wind and biomass generators.

Distribution customers may choose to obtain their electricity from NSTAR as the retail supplier (basic/default service) or a competitive retail supplier. Customers are typically placed on basic service, unless they elect to contract with a competitive supplier. NSTAR procures electricity as a market participant from generators on behalf of its basic service customers. Procurements take the form of short- and medium-term power purchase agreements for a large fraction of NSTAR's demand, with the balance obtained through spot market transactions. NSTAR's energy procurement costs are passed through to



basic service customers through rates approved by the Department of Public Utilities. On the other hand, the rates offered by competitive suppliers are not subject to regulation. However, NSTAR still acts as a billing agent for energy costs in most cases, whereby customers see a single bill that includes charges for energy and network services. Table 8 lists NSTAR's regulated basic service rates, with an option for fixed semi-annual rates or variable monthly rates. The energy rates are identical across all of NSTAR's customer categories, indicating the separation between energy and network costs (not shown here). Distributed generators receive net-metered payments using one of the retail rates based on their customer category, as listed in the table.

**Table 8. Basic Service Energy Rates for NSTAR Customers in the Cambridge Zone (c/kWh, 2010)**

Data Source: NSTAR (2009)

<b>Fixed Rate Pricing Option for Basic Service</b>						
The fixed rate pricing option for Basic Service beginning January 1, 2010 is (all pricing is in cents per kilowatt hour):						
<b>Residential Customers</b> January 1, 2010 to June 30, 2010 Rates A1, A2, A3, A4, A5, A7, A8, 32, 66, 68, 30, 37, 38, 86, 42, 57, 58, 59, 39, D1, 04, 05, 07, 48, 10			8.880			
<b>Small Commercial/Industrial Customers and Lighting</b> January 1, 2010 to June 30, 2010 Rates A9, B1, B2, B5, B9, C1, C2, C3, 22, 23, 31, 33, 35, 41, 55, 79, 81, 82, 88, 02, 06, 19, 36, 51, 52, 80			9.389			
<b>Large Commercial/Industrial Customers (NEMA)</b> January 1, 2010 to March 31, 2010 Rates B3, B7, 62, 70			9.377			
<b>Large Commercial/Industrial Customers (SEMA)</b> January 1, 2010 to March 31, 2010 Rates G6, G8, 24, 84			9.123			
<b>Monthly Variable Rate Pricing Option for Basic Service</b>						
The monthly variable rate pricing option for Basic Service beginning January 1, 2010 is (all pricing is in cents per kilowatt hour):						
<b>Residential Customers</b> January 1, 2010 to June 30, 2010 Rates A1, A2, A3, A4, A5, A7, A8, 32, 66, 68, 30, 37, 38, 86, 42, 57, 58, 59, 39, 01, 04, 05, 07, 48, 10						
January	February	March	April	May	June	
9.507	9.720	8.464	8.661	8.224	8.454	
<b>Small Commercial/Industrial and Lighting Customers</b> January 1, 2010 to June 30, 2010 Rates A9, B1, B2, B5, B9, C1, C2, C3, 22, 23, 31, 33, 35, 41, 55, 79, 81, 82, 88, 02, 06, 19, 36, 51, 52, 80						
January	February	March	April	May	June	
10.069	10.378	9.089	9.122	8.685	8.963	
<b>Large Commercial/Industrial Customers (NEMA)</b> January 1, 2010 to March 31, 2010 Rates B3, B7, 62, 70						
January	February	March				
9.465	9.857	8.813				
<b>Large Commercial/Industrial Customers (SEMA)</b> January 1, 2010 to March 31, 2010 Rates G6, G8, 24, 84						
January	February	March				
9.229	9.553	8.529				

To illustrate the relative magnitude of costs at the distribution level, NSTAR's financial flows for a single year are analyzed, as shown in Figure 4. About 50% of NSTAR's annual expenses can be attributed to energy procurement. In comparison, transmission and distribution network expenses are 6.2% and 4.5% respectively. This indicates that network-related expenditure is a small fraction of NSTAR's operations, even though it is a large distribution company.

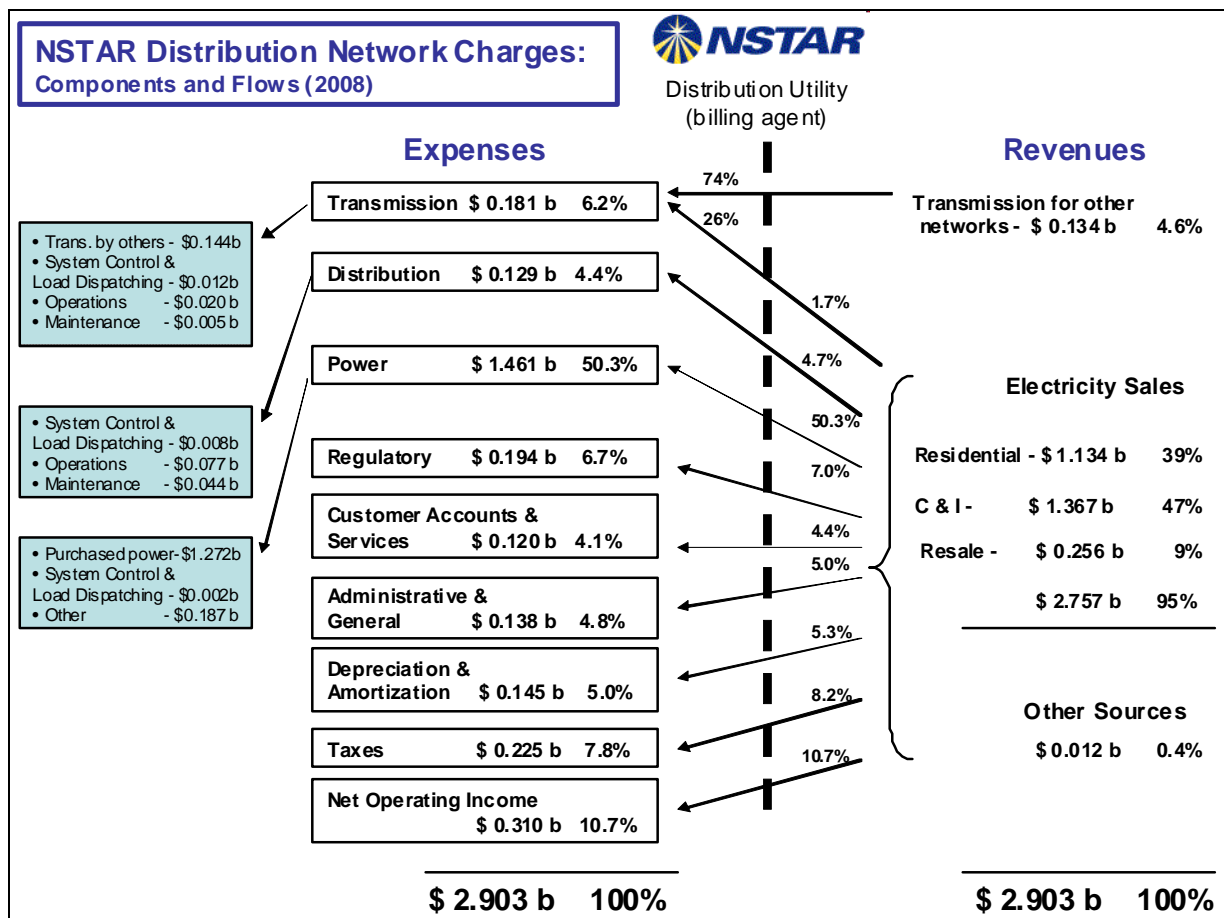

Figure 4. NSTAR Distribution Network Charges (2008)

Data Source: NSTAR (2009)

Although the examples used here are specific to NSTAR, the general tariff design is identical across investor-owned utilities in the state of Massachusetts and similar to utilities in other states in the New England region. Some instances of differences in tariff structure are daily connection charges for Central Vermont Public Service in the state of Vermont, and seasonal time-of-use rates in the Central Maine Power Corporation in Maine, both states with agricultural customers and large rural tracts. Such differences reflect the cost of network services at the distribution level in those states, based on their sparser concentration of residential and industrial customers. However, in densely populated states such as Massachusetts and Connecticut, the distribution network costs are similar across different service territories. Moreover, zonal network tariffs in these states that are specific to each zone within the same distribution utilities' service area allow utilities to recover the costs of providing network services to customers specifically within the zone. Thus, averaging of network related costs across large segments of the population is minimized, and the network tariffs are more cost-reflective to the user.

# AUSTRALIA

Network tariffs in Australia differ primarily by state, because the networks are organized primarily by state boundaries. Within each state the network tariffs are differentiated by voltage level and time use. Large customers in some parts of the country have nodal tariffs based on the capacity and length of their connection to a particular node in the network, because of large geographical distances that must be covered between generation and load centers. Such demand length charges therefore influence the siting decisions of large customers. Distribution network tariffs are usually average charges across voltage categories with time of use differentiation. Distribution networks in Australia span large geographical service areas, and the lack of geographical variation in tariffs within a state implies cross-subsidization between customer groups, because it is more expensive to deliver network services to customers in rural areas than urban areas. Distributed generators in Australia receive regulated rates for the net-metered electricity supplied to grid. Additionally, they receive payments corresponding to the 'avoided transmission use of system charges' which would have otherwise been paid to the transmission network. This allows the transmission networks companies to recover their annual revenue requirements.

## 1. SYSTEM CHARACTERISTICS

Australia's electricity system is divided into three main sub-systems:

- an interconnected system in eastern and southern Australia, known as the National Electricity Market (NEM)
- the Western Australian system, further divided into
  - the Northwest Interconnected System (NWIS)
  - the Southwest Interconnected System (SWIS)
  - 29 regional, unconnected systems
- the Northern Territory system (NTS)

Figure 1 displays the relative location of the main sub-systems on the Australian landmass. The NEM operates in the world's longest interconnected power system, from Port Douglas in Queensland to Port Lincoln in South Australia, a distance of around 5,000 kilometers or 3100 miles. It includes the states of Queensland (Qld), New South Wales (NSW), Victoria (Vic), Southern Australia (SA), Tasmania (Tas) and

the Australian Capital Territory (ACT). The Western Australian system operates within the borders of the state of Western Australia (WA), while the Northern Territory system is limited to the Northern Territory (NT).

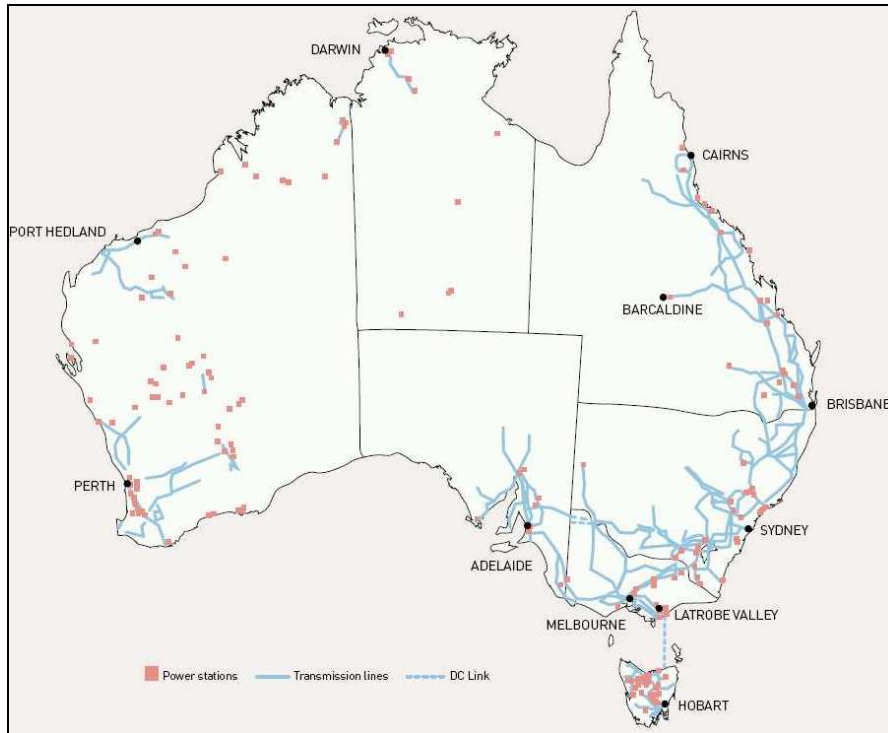

**Figure 1. Geographical Distribution of Electricity Networks in Australia**

Source: Australian Energy Regulator (AER) 2008

The primary reason for the subdivisions is the geography of Australia, and the influence it has on Australian demographics and industry. The industry and population centers in Western Australia are thousands of miles away from the NEM region. Attempting to connect generation sources in the NEM to load centers in Western Australia or the Northern Territory would be expensive. The main subsystems are therefore physically distinct and are not interconnected with each other. Nonetheless, studying all the main sub-systems is useful because each provides examples of separate and different network tariff designs all within the same country. Although the designs are similar in many respects, they are utilized in systems which have different network ownership, organization and regulatory structures. The similarity in designs is evidence of the fact that tariff designs are independent of the characteristics of the system in some ways. Postage-stamping for asset-independent network services such as ancillary services is one example of a similarity across all the Australian systems. However, network tariffs are heavily influenced by the system organization in other ways. This is found to be the case when network tariffs are unbundled from energy costs in systems with wholesale electricity markets and retail suppliers

as in the NEM. On the other hand, vertically integrated monopolies as in the Northern Territory offer bundled (integral) tariffs. These distinctions affect the treatment of large and small customers, or small generators such as distributed generators. Before exploring the tariff designs in detail, the general system characteristics of the main sub-systems in Australia will first be discussed.

## 1.1 Generation

Due to physical separation of the sub-systems, distinctions in ownership and regulatory structure are observed in the generation sectors of the sub-systems. Australia has about 244 large electricity generators as shown in Figure 1, of which around 190 are in the National Electricity Market jurisdictions in eastern and southern Australia. A number of smaller generators are connected at distribution voltage levels (embedded or distributed generators) and operate independent of the market. Table 1 summarizes the generation profile of the various systems.

**Table 1. Generation Sector Profile in Australia’s Electricity Systems**

Data Source: Australian Energy Regulator, Economic Regulatory Authority,  
Northern Territories Utilities Commission (2009)

Region	NEM	WA	NT
<b>Number of Customers</b>	8,700,000	925,000	82,000
<b>Capacity (MW)</b>	44,390	6,117	649
<b>Fuel Source</b>			
Coal	66%	35%	
Gas	15%	60%	0.9
Hydro	17%	4%	
Wind	1%		
Other	1%	1%	
<b>Ownership / Control (% by capacity)</b>			
Government	67%	57%	73%
Private	33%	43%	27%
<b>Structure</b>	Market	Market (SWIS) Regulated (NWIS)	Regulated

Generation in the NEM operates under the framework of a wholesale electricity market. The NEM is a gross pool, in which all generators sell into the market through a central trading platform. Retail suppliers, who are the primary customers, purchase electricity directly from the pool. Bilateral contracts between generators and customers are prohibited. The NEM also does not have provisions for capacity or availability payments where generators are paid to be available to supply electricity in periods of very high demand. As a result, the NEM is an energy-only market. Ancillary services in the NEM are procured

through ancillary services markets, similar to the wholesale market. The existence of a wholesale market with a well-functioning retail sector implies that the network owners can recover the network-related costs independent of the energy transactions, although either the network company or the retail supplier might serve as the billing agent for both types of costs.

Market and network operation in the NEM is the responsibility of the Australian Energy Market Operator (AEMO) under the provisions of the National Electricity Law. It acts as the billing agent for the transactions involving wholesale supply, delivery and retail supply of electricity. The AEMO also operates the ancillary services markets, and serves as the transmission planner for the NEM.

A wholesale market was also established in the Southwest Interconnected System in 2006. The market operates as a net pool, where generators and customers first enter into bilateral contracts, and the unsupplied demand is procured in the spot market. The SWIS has provisions for capacity payments, unlike the NEM. However, it has a retail sector as in the NEM, where Synergy is the primary retailer in the SWIS service area. Synergy acts as the billing agent for both energy costs and network tariffs.

The Northwest Interconnected System and Northern Territory system do not have a wholesale market because of their small generation capacities of only 400 MW and 650 MW respectively. In the NWIS, electricity is procured from independent generators by the Horizon Power, the regional distributor, and supplied to customers.

The Northern Territory has a bilateral contracting system where Power and Water, the monopoly generator, contracts directly with customers. Six independent power producers that generate electricity for their own use also supply electricity to Power and Water under Power Purchase Agreements.

The two types of organization in the generation sector (market and vertically integrated) and the existence of retail supply in some parts of the systems influences the network tariffs that customers see. The main implication is architectural, i.e. the design is either an integral tariff or separate energy and network tariffs.

## **1.2 Networks**

### ***National Electricity Market***

The transmission networks in the NEM are organized primarily by state jurisdiction with interconnections between states that belong to the NEM network. As the largest electricity system in Australia, the NEM also has the highest number of transmission networks. Similarly, 13 of Australia's 15 major distribution networks are located in the NEM.

**Table 2. Transmission Network Characteristics in Australia's NEM**

Data Source: AER (2009), Note: 1 AUD = USD 0.924 = EUR 0.695 on May 1, 2010

Network	Location (state)	Owner	Line Length (km)	Regulatory Structure	Regulated Asset Base (2007 AUD millions)	Current Investment (2007 AUD millions)
<b>Transmission</b>						
TransGrid	NSW	State Govt	12,489	Revenue Cap	3,013	1,184
Energy Australia	NSW	State Govt	1,040	Revenue Cap	636	230
SP AusNet	Vic	Joint Venture	6,500	Revenue Cap	2,191	947
Powerlink	Qld	State Govt	12,000	Revenue Cap	3,753	2,418
ElectraNet	SA	Joint Venture	5,611	Revenue Cap	1,251	655
Transend	Tas	State Govt	3,645	Revenue Cap	604	362
<b>Total</b>			<b>41,285</b>		<b>11,448</b>	<b>5,796</b>
<b>Interconnectors</b>						
Murraylink	Vic-SA	Private	180	Revenue Cap	103	-
Directlink	Qld-NSW	Private	63	Revenue Cap	117	-
Basslink	Vic-Tas	Private	375	Merchant	780	-
<b>Total</b>			<b>618</b>		<b>1,000</b>	

**Table 3. Distribution Network Characteristics in Australia's NEM**

Data Source: AER (2009)

Network	Location (state)	Owner	Line Length (km)	Regulatory Structure	Regulated Asset Base (2007 AUD millions)	Current Investment (2007 AUD millions)
EnergyAustralia	NSW	State Govt	47,144	Price Cap	4,116	2,455
Integral Energy	NSW	State Govt	33,863	Price Cap	2,283	1,733
Country Energy	NSW	State Govt	182,023	Price Cap	2,375	1,539
ActewAGL	ACT	Joint Venture	4,623	Revenue Cap	510	115
Solaris	Vic	Private	5,579	Price Cap	578	253
SPAusNet	Vic	Private	29,397	Price Cap	1,307	755
United Energy	Vic	Private	12,308	Price Cap	1,220	547
CitiPower	Vic	Private	6,488	Price Cap	991	529
Powercor	Vic	Private	80,577	Price Cap	1,626	1,008
ETSA Utilities	SA	Private	80,644	Revenue Yield	2,468	810
Energex	Qld	State Govt	48,115	Revenue Cap	4,308	3,011
Ergon Energy	Qld	State Govt	142,793	Revenue Cap	4,198	2,945
Aurora Energy	Tas	State Govt	24,400	Revenue Cap	981	575
<b>Total</b>			<b>697,954</b>		<b>26,961</b>	<b>16,275</b>

Table 2 summarizes the characteristics of transmission systems in the NEM. Transmission is concentrated along the eastern and southern coastline, reflecting the population density of those areas. The total length of all the transmission lines in the NEM regions is approximately 41,300 km (25,500 miles). Transmission networks are mostly state-owned, with a small share of private ownership. The Basslink interconnection between New South Wales and Tasmania is currently the only transmission link that is merchant-owned. The Australian Energy Regulator regulates all the transmission networks and interconnectors except Basslink, which is a merchant line. The main transmission networks have a revenue cap review period of five years, whereas the regulated interconnectors have a period of 10 years.

Distribution networks in the NEM are government-owned in New South Wales, Queensland and Tasmania, and privately owned or leased in Victoria and South Australia. The ACT area has joint government and private ownership. The total length of distribution lines in the NEM is approximately 698,000 kilometers (434,000 miles). Table 3 summarizes the characteristics of distribution systems in the NEM.

The transmission and distribution networks are operated by the Australian Energy Market Operator (AEMO). The AEMO is also the national transmission planning entity.

The Regulated Asset Base (RAB) is the financial value of network assets that is used as a basis for determining the revenue requirements for network owners. The combined RAB of all transmission networks in the NEM, including interconnectors is around AUD 12.4 billion, whereas the RAB for distribution networks is AUD 26.9 billion. The Regulated Asset Base (RAB) for each network is determined at the beginning of the review period. As a merchant line, Basslink does not have a RAB; however, its estimated construction cost is AUD 780 million. The investment data for each network is the total investment over the complete review period, and includes incurred as well as forecast investments. Investments during a period are added into the RAB at the end of that period.

Table 10 lists the forecast capital and operating expenses and the Annual Revenue Requirements (ARR) for Energex and Ergon, two of the largest distributors in the NEM. Both are located in Queensland and are connected to the Powerlink transmission network. The total revenues collected from all distribution customer categories must meet the ARR, which is approved by the Queensland Competition Authority as part of the five-year revenue cap process.



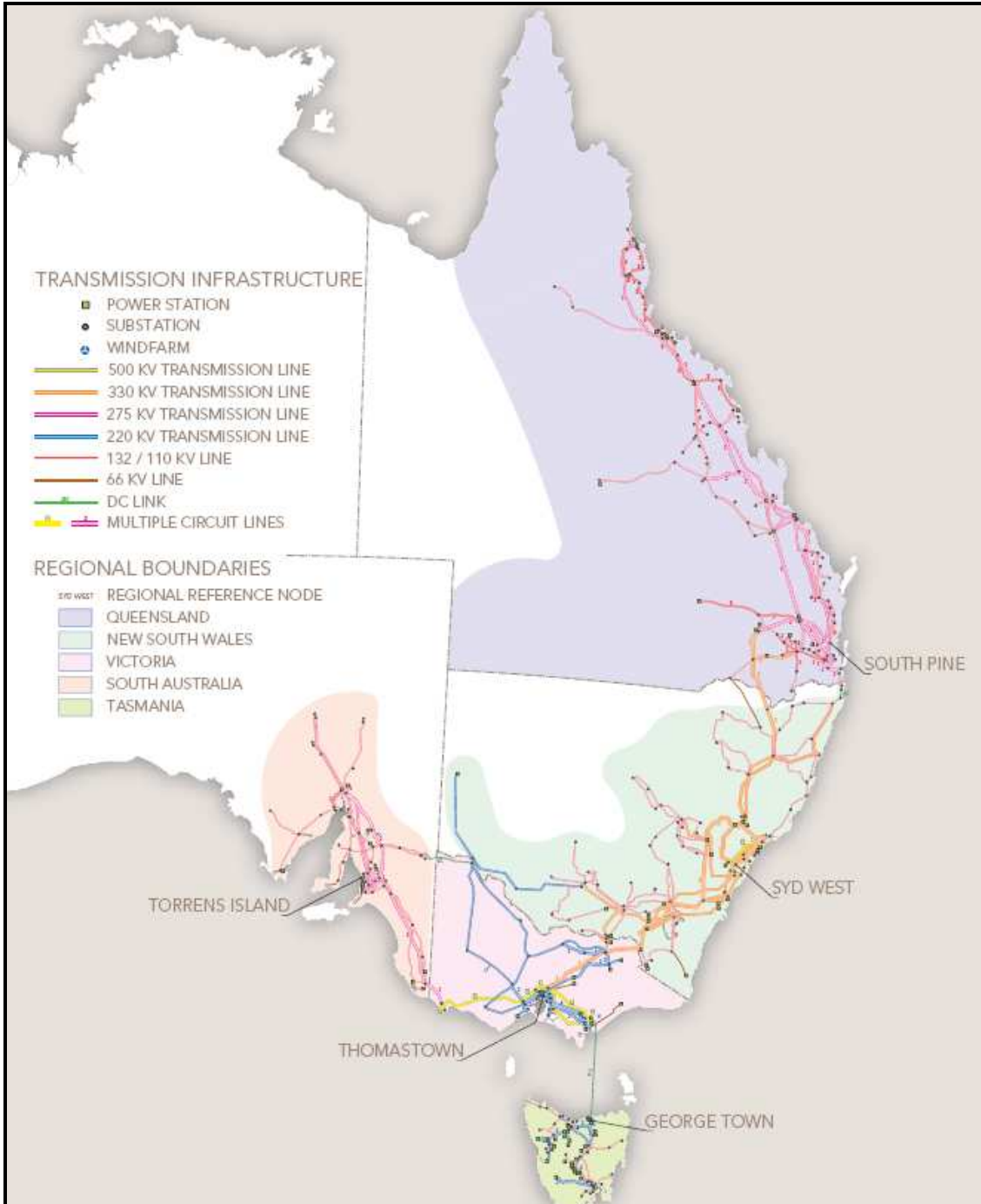

**Figure 2. Network Map of the National Electricity Market**

Source: Australian Energy Market Operator (AEMO 2009)

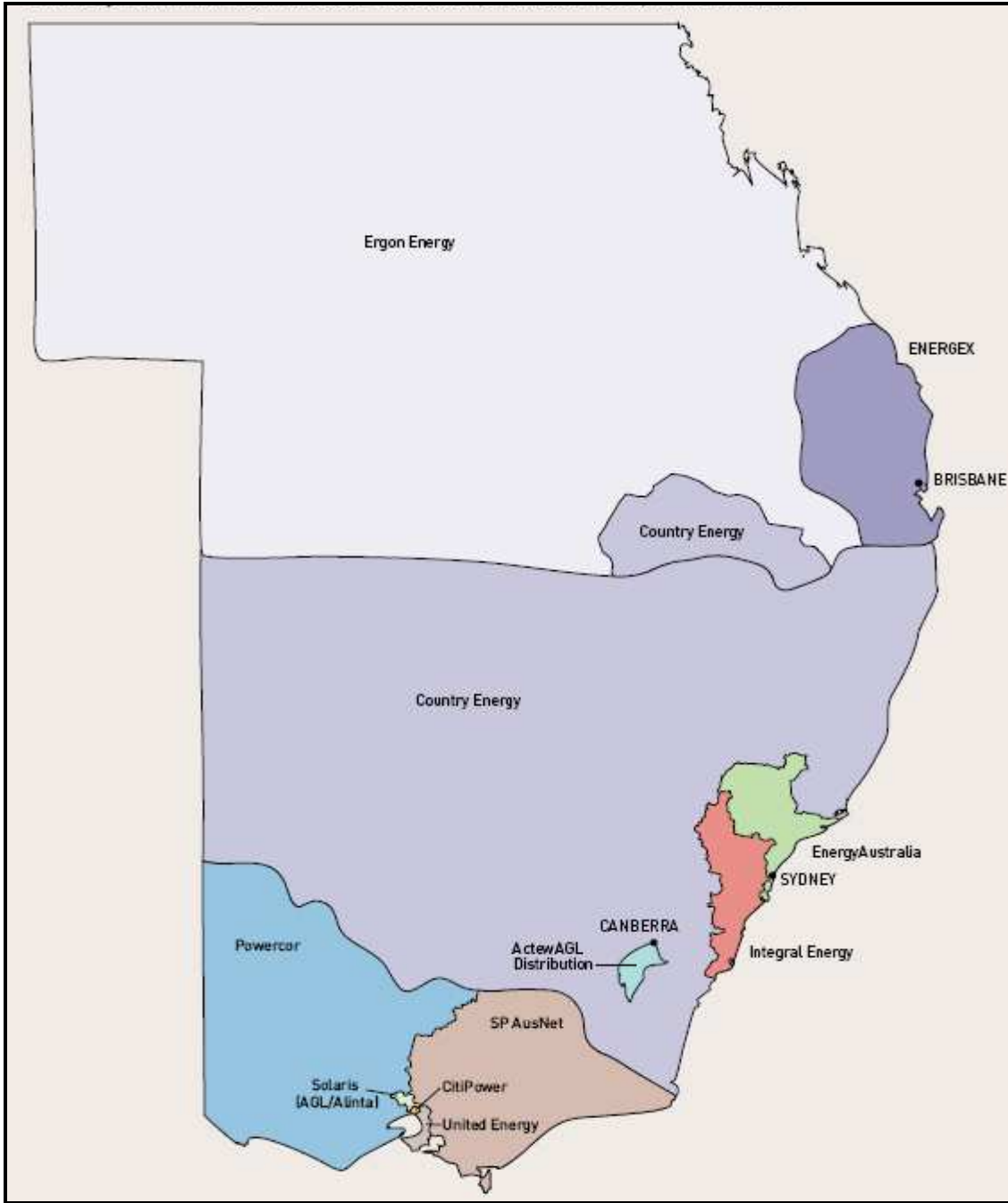

Figure 3. Distribution Network Service Areas in the NEM

Source: AER 2009

## Western Australia

Both transmission and distribution networks in Western Australia are owned by Western Power, a state-owned entity. Western Power's network characteristics are summarized in Table 4.

**Table 4. Network Characteristics in Western Australia**

Data Source: Western Power, AER (2009)

Network	Location (state)	Owner	Line Length (km)	Regulatory Structure	Regulated Asset Base (2007 AUD millions)	Current Investment (2007 AUD millions)
WP Transmission	WA	State Govt	6,623	Revenue Cap	1,387	626
WP Distribution	WA	State Govt	69,083	Revenue Cap	1,595	907

The Western Australian electricity system is sub-divided into the SWIS and NWIS, as shown in Figure 4. The SWIS is the major interconnected network in Western Australia with approximately 6,000 kilometers (3700 miles) of transmission lines and 64,000 kilometers (40,000 miles) of distribution lines (AER 2009). It serves Perth and other population centers in the southwest. Western Power owns the transmission and distribution networks in the SWIS. A ring-fenced entity within Western Power, System Management, is the system operator and controls generators, networks and load. Electricity is procured from the net pool wholesale market by Synergy, the primary retail supplier.

The NWIS is significantly smaller in size than the SWIS, because it serves only the industrial towns and mining centers in the northwest. Horizon Power operates the networks and provides retail supply throughout the NWIS. Electricity is procured from the privately-owned generators in the region.

The 29 small unconnected distribution systems in Western Australia are located in rural and remote areas beyond the SWIS and NWIS. These systems also serve industrial or mining townships and are operated by Horizon Energy.

Western Power's RAB for transmission is approximately AUD 2 billion, and approximately AUD 2.5 billion for distribution networks. Networks are regulated under a revenue cap with a 2 year review period for transmission and 3 year period for distribution.



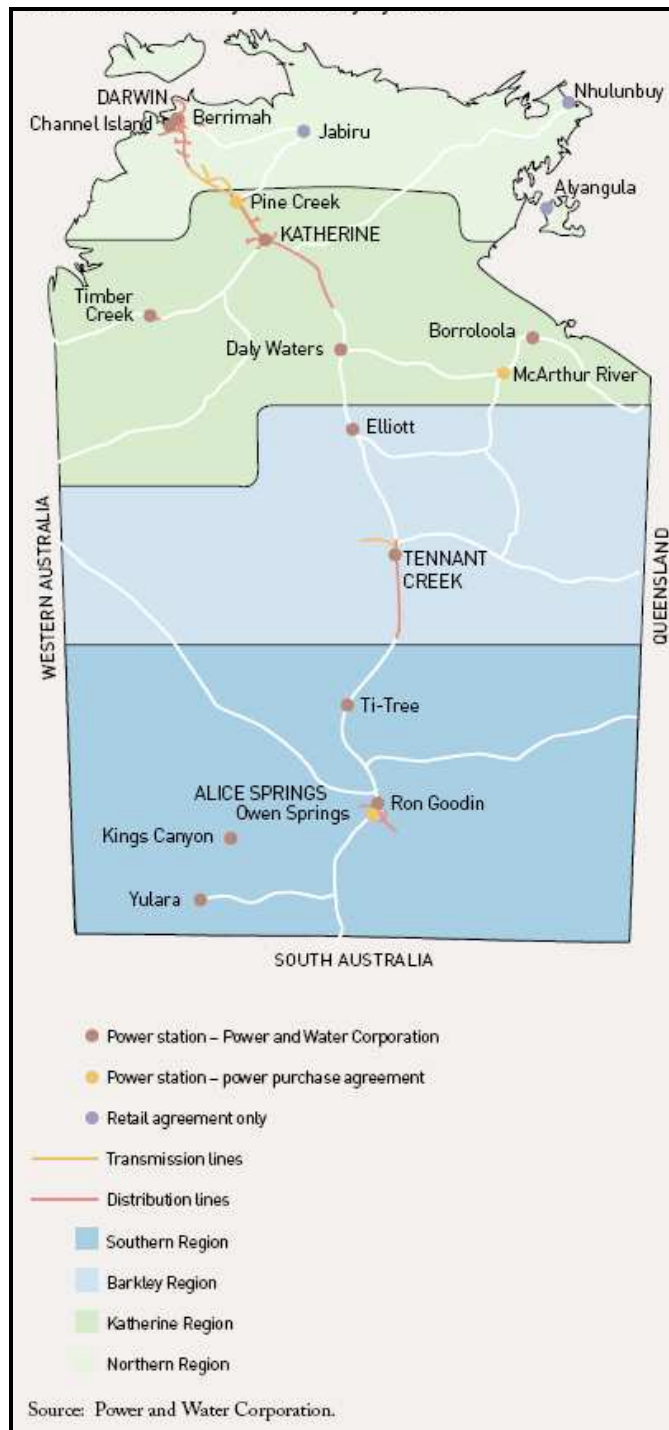

Figure 5. Network Map of the Northern Territory

Source: AER 2009

## **Northern Territory**

The transmission and distribution networks in the Northern Territory are owned and operated by a Power and Water Corporation, a state-owned company. Power and Water is also the sole generator and retail supplier (Figure 5).

**Table 5. Network Characteristics in the Northern Territory**

Data Source: Western Power, AER (2009)

<b>Network</b>	<b>Location</b> (state)	<b>Owner</b>	<b>Line Length</b> (km)	<b>Regulatory Structure</b>	<b>Regulated Asset Base</b> (2007 AUD millions)	<b>Current Investment</b> (2007 AUD millions)
Power and Water	NT	State Govt	6,619	Revenue Cap	432	-

Power and Water's total RAB for both its transmission and distribution network is approximately AUD 430 million. The networks are regulated under a revenue cap with a five year review period. Power and Water's vertically integrated structure implies that customers see an integral tariff that includes both energy and network costs.

## **2. TARIFFS**

The three electricity sub-systems in Australia have many similarities and some differences in tariff design as described below.

### **2.1 National Electricity Market**

The 13 distribution systems in the six states of the NEM are connected to the transmission network of each state and are regulated according to the National Electricity Rules as well as the state guidelines. Ergon Energy's (Queensland) tariff design is used as an example of the 13 distribution companies in the NEM, because Ergon is one of the largest distributors in terms of both line length and Regulated Asset Base. Ergon's tariffs are approved by the Queensland Competition Authority (QCA) to ensure compliance with Queensland Electricity Industry Code and the National Electricity Rules. As a Supplier of Last Resort (SoLR), Ergon also provides retail services to many customers in Queensland. The design described in this section is for network access tariffs and does not include retail pricing schemes. However, the design also applies to retailers as customers procuring electricity on behalf of end-users.

Transmission costs from Powerlink, Queensland's transmission company are included as a pass through in this design.

**Table 6. Network Tariff Design in the NEM**

Data Source: Ergon Energy, Queensland Competition Authority (2009)

<b>NEM (Ergon Energy)</b>					
	<b>Cost Components</b>	<b>Customer Type</b> (by consumption)	<b>Cost Allocation</b>	<b>Rate Structure</b>	<b>Variations</b>
<b>Connection Charges</b>	Connection assets; Network reinforcement	Very Large	Dedicated	Fixed daily (\$/day)	
		Large	Dedicated	Fixed daily (\$/day)	
		Small	Average by voltage category	Fixed daily (\$/day)	
		Distributed Generator	Dedicated	Fixed daily (\$/day)	
<b>Distribution UoS Charges</b>	Shared network use; Common services like system control; Administrative costs of network operation	Very Large	Zonal, proportional to use	Monthly capacity or actual demand (\$/kW/month) and volume (\$/kWh)	
		Large	Zonal, average by voltage category	Monthly capacity or actual demand (\$/kW/month) and volume (\$/kWh)	Peak/off-peak
		Small	Zonal, average by voltage category	Monthly capacity or actual demand (\$/kW/month) and volume (\$/kWh)	Peak/off-peak
		Distributed Generator	Only if consuming; by size as above	Only if consuming; by size as above	
<b>Transmission UoS Charges</b>	Shared network use; Common services like ancillary services; Administrative costs of network operation	Very Large	Locational by connection point, postage stamp	Monthly capacity (\$/kW/month), fixed daily (\$/day), daily service charge (\$/day) and volume (\$/kWh)	
		Large	Locational by connection point, postage stamp	Monthly capacity (\$/kW/month), fixed daily (\$/day), daily service charge (\$/day) and volume (\$/kWh)	
		Small	Locational by connection point, postage stamp	Monthly demand (\$/kW/month) and/or fixed daily (\$/day) and volume (\$/kWh)	
		Generator	Locational, postage stamp	Daily capacity (\$/kW/day)	
<b>Commercial Services</b>	Meter installations and reading; billing services	All	Average partially weighted by consumption	Fixed daily (\$/day) and volume (\$/kWh)	
<b>Energy Policy</b>	Renewable Energy	All	Surcharge	Fixed (\$/year); increasing by consumption blocks	

Connection charges in the NEM are recovered as deep charges, where dedicated connection equipment and some or all of the reinforcement costs are recovered from the connecting network user. All network users, except small customers, pay deep connection charges. Small users pay an average connection charge. Charges are in the form of a fixed daily charge (\$/day) for each day that a user is connected to the network over the billing cycle. When network reinforcements or expansion paid for by previous network users benefits subsequent customers, the new customers may be required to pay for reimbursements to the original users through the connection charge. This provision is limited to new

users connecting within five years of the date of connection of the first user in a particular area of the network.

Distribution Use-of-System charges in the NEM vary by customer type. Very large customers are charged for network assets dedicated for their use in the form of a capacity charge (\$/kW). Large customers are charged by capacity (\$/kW) in proportion to their use of shared system assets at their voltage level. Small customers are charged for the average use of assets for their voltage category, either in the form of a monthly demand charge (\$/kW/month) at higher voltage levels, or only by volume of energy consumed (\$/kWh) at lower voltage levels.

Transmission Use-of-System charges are levied on distribution networks as transmission customers procuring transmission network services. Transmission network costs are allocated to locations or zones in the transmission network. Users connecting to connection points in a zone pay charges for network use that is specific to that zone. Some general or common transmission costs such as ancillary services that are not asset-related are recovered from all network customers on a postage stamp basis. Transmission UoS charges are subsequently allocated and passed through to distribution network users.

Table 7 lists selected tariff schemes from Ergon Energy's network tariffs to illustrate the charge structure for most small customers and the lower number of large customers. The schemes shown below are consistent with the tariff design described in Table 6. Transmission Use of System charges calculated based on the zonal allocation are passed through wherever applicable.

Apart from paying for the dedicated connection assets and network reinforcements, distributed generators are charged for network use only when they act as a load. Generators that do not draw electricity from the network do not pay for use of the distribution network. If they do draw electricity at any time, they are charged according to their consumption size as described above. For example, a manufacturing facility with solar installations may supply its surplus electricity to the grid at some times of the year, and draw electricity at others. It will be treated as a consumer at those times, and be responsible for charges appropriate to its size and network use.

Transmission UoS charges do not apply to distributed generators for the periods when they are supplying electricity to the grid. In fact, distributed generators are paid an amount corresponding to the *avoided transmission Use-of-System charge*. The distributor, Ergon, calculates the transmission UoS charges that the distribution company would have paid to the transmission system, had the distributed generator not supplied any energy at its connection point. The difference between the calculated amount and the distribution network's actual payments to the transmission system is defined as the *avoided transmission UoS charge*. The amount corresponding to the avoided charge is not considered part of the distribution network's revenue requirement and is recovered through the transmission UoS component from



customers connected to the same connection point as the distributed generator. The amount is paid to the distributed generator instead of the transmission network.

**Table 7. Selected Network Tariff Schedules for Ergon Energy**

Data Source: Ergon Energy, Queensland Competition Authority (2009), Note: Values in AUD

STANDARD ASSET CUSTOMERS < 100MWh per annum - VOLUME SMALL GST Inclusive					
Network Tariff Code	Distribution Use Of System (DUOS)		Transmission Use Of System (TUOS)		Minimum monthly charge if no usage recorded. (based on 30 days in month)
	Fixed Charge (NDFC)	Volume Charge (NDVC)	Fixed Charge (NTFC)	Volume Charge (NTVC)	
	dollars per day	dollars per kilowatthour	dollars per day	dollars per kilowatthour	
EVST1	\$0.860	\$0.06544	\$0.120	\$0.00853	\$29.40
EVST2	\$0.860	\$0.06544	\$0.187	\$0.01060	\$31.42
EVST3	\$0.860	\$0.06544	\$0.296	\$0.01397	\$34.68
WVST1	\$0.952	\$0.23082	\$0.120	\$0.00853	\$32.14
WVST2	\$0.952	\$0.23082	\$0.187	\$0.01060	\$34.16
WVST3	\$0.952	\$0.23082	\$0.296	\$0.01397	\$37.42

STANDARD ASSET CUSTOMERS > 100MWh per annum - DEMAND HIGH VOLTAGE GST Inclusive								
Network Tariff Code	Minimum Chargeable Demand	Distribution Use Of System (DUOS)			Transmission Use Of System (TUOS)			Minimum monthly charge if no usage recorded. (based on 30 days in month)
		Fixed Charge (NDFC)	Actual Demand Charge (NDADC)	Volume Charge (NDVC)	Fixed Charge (NTFC)	Capacity Charge (NTCC)	Volume Charge (NTVC)	
	kilowatts	dollars per day	dollars per kilowatt per month	dollars per kilowatthour	dollars per day	dollars per kilowatt per month	dollars per kilowatthour	
EDHT1	400	\$16.445	\$11.014	\$0.00272	\$2.340	\$0.831	\$0.00853	\$5,301.46
EDHT2	400	\$16.445	\$11.014	\$0.00272	\$2.815	\$1.817	\$0.01060	\$5,710.40
EDHT3	400	\$16.445	\$11.014	\$0.00272	\$3.389	\$3.820	\$0.01397	\$6,528.86
WDHT1	400	\$20.633	\$31.569	\$0.00523	\$2.340	\$0.831	\$0.00853	\$13,648.93
WDHT2	400	\$20.633	\$31.569	\$0.00523	\$2.815	\$1.817	\$0.01060	\$14,057.87
WDHT3	400	\$20.633	\$31.569	\$0.00523	\$3.389	\$3.820	\$0.01397	\$14,876.33

**Table 8. Queensland Net-Metering Rate Schedule for Ergon Energy**

Data Source: Ergon Energy, Queensland Competition Authority (2009), Note: Values in AUD

QLD GOVT SOLAR BONUS SCHEME FOR STANDARD ASSET CUSTOMERS <100MWh Per Annum GST Inclusive				
Network Tariff Code	Distribution Use Of System (DUOS)		Transmission Use Of System (TUOS)	
	Fixed Charge (NDFC)	Volume Charge (NDVC)	Fixed Charge (NTFC)	Volume Charge (NTVC)
	dollars per day	CENTS per kilowatthour	dollars per day	dollars per kilowatthour
NVG0		0.00		
NVG1		-44.00		
GVG0		0.00		

The 44c/Kwh associated with the Solar PV Bonus Scheme includes GST (if any). As such, no amount will be added to the credit in respect of any GST payable.

In addition to the avoided transmission Use-of-System charge, solar generators connected to Ergon's network are eligible for net metering, as shown in Table 8. If such generators supply surplus electricity back to grid, they receive 44 c/kWh under the Queensland solar bonus scheme. This rate is significantly higher than the Use of System charges paid by such customer. Solar distributed generators in Queensland therefore have an incentive to connect and supply electricity to the grid through the two mechanisms of avoided charges and net metered payments.

Costs of commercial services such as meter reading and billing are not allocated to specific customer types but recovered from all customers using the service. Customers pay a fixed daily charge (\$/day) which is an average cost across all customers, weighted by their consumption.

The cost of electricity procured by the distribution company is passed through consumers through the energy charge (\$/kWh). Customers can choose to obtain their electricity from renewable sources by paying a fixed surcharge (\$/year) to allow the distribution company to recover the surplus cost of more expensive electricity.

**Table 9. Selected Retail tariffs for Ergon Energy**

Data Source: Ergon Energy, Queensland Competition Authority (2009), Note: Values in AUD

Tariff	Fixed Supply Charges	Energy Charges		
	(\$/month minimum)	(c/kWh)		
	<b>Single Rate</b>			
Domestic (T11)	7.25	18.84		
Domestic Night-rate (T31)	5.05	7.69		
Domestic Controlled Supply (T33)	5.05	11.32		
Rural/C&I (T20)	13.15	21.12		
	<b>Differentiated Rate (consumption)</b>			
		First 100 kWh/month	Next 9,900 kWh/month	Excess
General (T21)	11.75	26.24	24.64	18.76
	<b>Differentiated Rate (time of use)</b>			
		Peak	Off-peak	Weekend
General Supply (T22)	28.95	25.66	9.04	9.04
	<b>Differentiated Rate (demand time of use)</b>			
	(\$/month minimum)	Peak (c/kWh)	Off-peak (c/kWh)	Demand (\$/kw)
General Demand (T43)	44.32	13.31	5.32	13.46

Table 9 lists some selected retail tariffs from Ergon Energy that are illustrative of the cost pass through end use customers. The fixed supply charges include network connection costs as well as metering and administrative expenses for Ergon. For most customers, Ergon is the distributor as well as the retailer and therefore acts as the billing agent. The retail tariffs are much higher than the network tariffs shown in Table 7, because they include the energy costs and other retail expenses. The retail tariffs are seen as integrated tariffs from the point of view of the end use customer. As the retail tariffs are identical for all customers in the Ergon service area, the locational signals observed in the distribution and transmission Use of System charges are lost through averaging.

## 2.2 Western Australia

The tariff design for Western Power's network service in Western Australia is similar to the tariff designs in the NEM, with a few important differences in cost allocation, capacity and demand charge calculations (kVA versus kW). Connection charge design for network users is identical to that in the NEM, except for distributed generators. In Western Australia, such generators pay a daily charge that is proportional to the capacity of their connection. The charge structure for commercial services in (\$/day) and (\$/kWh) are similar to those in the NEM. The network tariff designs for different user groups are summarized in Table 10.

Table 11 lists the network tariff charges for some customer categories to illustrate the quantitative range and scale of the tariffs. This is not an exhaustive list of all tariff categories, but is still representative of the architectural elements described in Table 10.

Distribution Use-of-System charges are similar to those in the NEM in terms of cost allocation. Users pay average charges that reflect the zonal cost of delivering electricity to that zone. This is indicated by the fixed supply charge that is identical over a number of categories. Both small and large users can choose a tariff that has provisions for peak and off-peak prices, allowing them to manage their period of consumption. The transmission Use of System charges are allocated in the form of energy prices by volume (c/kWh) and do not have a fixed costs component for the listed tariff categories. However, there are some daily connection charges and charges for common services based on the connection capacity (c/kW/day), which are discussed below.

Large and very large users also pay demand charges for daily metered demand (\$/kVA/day) and daily demand length ((\$/kVA.km/day) which reflect the cost of assets dedicated for their use (Table 12). The value used to calculate the metered demand or demand length charge is the peak value in a rolling 12-month period. Thus, large users can lower their demand charges by lowering peak demand. Additionally, such users receive a discount for consuming electricity during off-peak periods, based on the

ratio of total off-peak to peak consumption during the billing cycle. Demand length charges provide network users an incentive to locate closer to the zonal substation or point of connection to the transmission network.

**Table 10. Network Tariff Design in Western Australia**

Data Source: Western Power, Economic Regulatory Authority (2009)

<b>Western Australia (Western Power / Horizon Power)</b>					
	<b>Cost Components</b>	<b>Customer Type (by consumption)</b>	<b>Cost Allocation</b>	<b>Rate Structure</b>	<b>Variations</b>
<b>Connection Charges</b>	Connection assets; Network reinforcement	Very Large	Dedicated	Fixed daily (\$/day)	-
		Large	Dedicated	Fixed daily (\$/day)	-
		Small	Average	Fixed daily (\$/day)	-
		Distributed Generator	Dedicated	Daily capacity (\$/kW/day)	-
<b>Distribution UoS Charges</b>	Shared network use; Common services like system control; Administrative costs of network operation	Very Large	Zonal	Daily capacity (\$/kVA/day) and / or daily demand length (\$/kVA.km/day)	-
		Large	Zonal	Volume (\$/kWh) or daily metered demand (\$/kVA/day)	Peak / Off-peak w/ discount for off-peak use
		Small	Zonal	Volume (\$/kWh)	Peak / Off-peak
		Distributed Generator	Zonal	Daily capacity (\$/kW/day)	-
<b>Transmission UoS Charges</b>	Shared network use; Common services like ancillary services; Administrative costs of network operation	Very Large	Locational	Daily capacity (\$/kVA/day) and / or daily demand length (\$/kVA.km/day)	
		Large	Locational	Volume (\$/kWh) or daily metered demand (\$/kVA/day) and / or daily demand length (\$/kVA.km/day)	Peak / Off-peak
		Small	Locational	Volume (\$/kWh)	Peak / Off-peak
		Generator	Locational	Daily capacity (\$/kW/day)	
<b>Commercial Services</b>	Meter installations and reading; billing services	All	Average	Fixed daily (\$/day) and volume (\$/kWh)	Peak / Off-peak
<b>Energy Policy</b>	Renewable Energy	All	Surcharge	Fixed (\$/year); increasing by consumption blocks	

Demand charges are calculated in the units of kVA, instead of kW, to allow users to manage their power factor. The effective demand for a power rating in kVA with a power factor lower than unity is higher than the same power rating expressed in kW. A user can lower effective demand by bringing the power factor close to unity. Large or very large users can also choose a tariff with contract maximum demand for the billing cycle and pay the corresponding (\$/kVA) charge. If users exceed their contracted demand, they pay a monthly penalty for the month in which demand was exceeded. The penalty provides customers with the incentive to manage their own demand below the contracted maximum. Additionally, it reduces the uncertainty of whether network expansion is necessary, and also keeps the expansion to a minimum.

**Table 11. Selected Network Tariff Categories of Western Power (2009-10)**

Data Source: Western Power, Economic Regulatory Authority (2009), Note: Values in AUD

		Fixed Price (c/day)	Energy Rates (c/kWh)		
			Single Rate	Peak	Off-peak
Anytime Residential (RT1)	Transmission	-	1.36	-	-
	Distribution	23.29	3.08	-	-
	Total	23.29	4.44	-	-
Anytime Business (RT2)	Transmission	-	1.63	-	-
	Distribution	23.29	4.35	-	-
	Total	23.29	5.98	-	-
Small Time of Use (RT3)	Transmission	-	-	2.53	0.53
	Distribution	23.29	-	4.94	1.14
	Total	23.29	-	7.47	1.68
Large Time of Use (RT4)	Transmission	-	-	2.08	0.50
	Distribution	29.19	-	4.50	1.03
	Total	29.19	-	6.59	1.53

**Table 12. Example of Demand-Length Tariffs for Large Western Power Customers (2009 AUD)**

Data Source: Western Power, Economic Regulatory Authority (2009)

Pricing Zone	Demand-Length Charge	
	For kVA >1000 and first 10 km length (c/kVA.km/day)	For kVA >1000 and length in excess of 10 km (c/kVA.km/day)
CBD	0.000	0.000
Urban	0.633	0.442
Mining	0.138	0.096
Mixed	0.297	0.208
Rural	0.207	0.145

Transmission UoS charges are nodal and use the locational price for delivering electricity at a particular node, based on the user's contract maximum demand. The transmission charges for users connected to the distribution network are passed through in the cost allocation for use of the distribution network as shown above.

Distributed generators are treated as large-scale generators connected at the transmission level. They pay a (\$/kW) charge for network use based on their declared generation capacity. The charge is calculated by using the transmission nodal price at the nearest transmission connection point. Such generators are not responsible for common or shared services that do not reflect asset-related costs. However, they also pay dedicated connection charges based on the capacity of their connection

(\$/kW/day). This treatment of distributed generators ensures that all generators in the Western Australian network are subject to the same requirements. However, the network tariff rates for distributed generators are much higher than for generators connected to the transmission level, because the tariffs include costs for the lower voltage levels of the network. On the other hand, the network tariffs line item in the bill could be low in magnitude because of the small generation capacity of distributed generators. Ultimately, such generators will have an incentive to operate if their revenues from total energy sold (\$/kWh) are higher than the sum of their network costs (\$/kW and \$/kW/day) and other operating costs.

Table 14 provides an exhaustive list of forecast revenues from all of Western Power's customer categories for 2009-2010. These figures represent Western Power's total revenue requirement, which includes its network-related costs and return on capital. As expected, revenues from the flat-rate residential category are the largest contribution for both transmission (AUD 69 M) and distribution (AUD 273 M) because of the large number of small residential customers. The contribution of high voltage contract customers (AUD 42 M) is a large component of revenues at the transmission level in addition to revenues from generators (AUD 47 M). Business customers appear to subscribe significantly to both flat-rate as well as time of use tariffs. As described above, demand management incentives for customers in these tariff categories can influence network use and the corresponding costs and revenues. Distributed generators do not contribute to tariff category RT11, because such generators are treated as high-voltage generators in the Western Australian network. Their revenues are therefore included in tariff category TRT2.

Table 15 shows a list of retail tariffs as provided by the retail supplier Synergy for some selected customer categories corresponding to those in Table 12. These retail tariffs include connection charges, use of system charges, energy costs and renewable energy surcharges such as Renewable Energy Credits (RECs). The tariffs shown here do not include one-time fees and administrative charges for reconnecting or disconnecting meters, commercial transactions, etc. Such administrative and commercial charges appear as separate line items on the customer's bill. The charges include a 10% Goods and Services Tax (GST).

By comparing Table 15 and 11, it is easy to observe that the retail fixed supply charges (c/day) are higher than the total fixed supply charges in the network tariffs. The difference can be attributed to the costs of retail supply which are over and above the network tariffs being charged by Western Power. It is more difficult to compare the retail energy charges and the Use of System charges because the retail charges include energy costs, and represent a significant amount of averaging so that all customers across Synergy's service area in the SWIS see the same retail tariffs. The observations are similar with Horizon Power's retail tariffs in the NWIS part of Western Australia.

**Table 13. Partial List of Nodal Transmission Use of System Tariffs (2009 AUD)**

Data Source: Western Power, Economic Regulatory Authority (2009)

Substation	Node Identification	Use of System Price
		(c/kW/day)
Albany	WALB	13.0
Alcoa Pinjarra	WAPJ	5.8
Amherst	WAMT	3.4
Boulder	WBLD	14.0
Bounty	WBNY	35.2
Bridgetown	WBTN	7.3
.	.	.
.	.	.
.	.	.
Yerbillon	WYER	20.7
Yilgarn	WYLN	11.8
Yokine	WYKE	4.9

**Table 14. Forecast Western Power Network Revenue Requirements (2009-10)  
(2009 AUD Millions)**

Data Source: Western Power, Economic Regulatory Authority (2009)

	kWh	Number Customers	Forecast Transmission Revenue Recovered	Forecast Distribution Revenue Recovered
TRT1 – Transmission Exit	N/A	27	19.3	0.0
TRT2 – Transmission Entry (includes LV Gens etc.)	N/A	26	46.6	0.0
RT1 - Anytime Energy (Residential)	5,112,296,250	856,826	69.5	273.5
RT2 - Anytime Energy (Business)	1,605,849,347	98,160	26.2	89.8
RT3 - Time of Use Energy (Residential)	159,593,976	15,797	2.1	7.1
RT4 - Time of Use Energy (Business)	1,912,186,676	12,451	24.9	57.6
RT5 - High Voltage Metered Demand	288,150,192	97	3.3	4.5
RT6 - Low Voltage Metered Demand	1,117,985,739	955	15.0	23.6
RT7 - High Voltage Contract Maximum Demand	3,034,636,365	190	41.8	20.7
RT8 - Low Voltage Contract Maximum Demand	303,036,136	53	4.1	4.5
RT9 – Streetlighting	103,494,423	210,015	1.1	15.6
RT10 - Un-Metered Supplies	32,386,702	14,441	0.2	1.7
RT11 - Distribution Entry	0	0	0.0	0.0
<b>TOTAL</b>	<b>13,669,615,806</b>	<b>1,209,038</b>	<b>254.1</b>	<b>498.7</b>

**Table 15. Synergy Retail Tariffs in the SWIS-Western Australia (2009-10) (2009 AUD)**

Data Source: Western Power, Economic Regulatory Authority (2009)

Tariff Type	Supply Charge	Energy Charge		
		<b>Single Rate</b> (c/kWh)		
Residential Flat Rate (A1)	(c/day) 32.33	17.61		
Off-peak Residential Water Heating (B1)	18.46	7.1		
		<b>Differentiated Rate (consumption)</b>		
		First 20 kWh/day	21 - 1650 kWh/day	More than 1650 kWh/day
Home Business Tariff (K1)	32.33	17.61	22.08	19.93
		First 1650 kWh/day		More than 1650 kWh/day
Business Plan (L1) (low/medium voltage 240/415 volts; < 50 MWh/yr)	30.68	20.16		18.19
Large Business (M1) (high voltage 6.6-33 kV; > 50 MWh/yr)	32.14	20.41		18.33
		<b>Differentiated Rate (time of use)</b> (c/kWh)		
	(\$/day)	Peak	Off-peak	Weekend
Business Time of Use (R1) (low/medium/high voltage 240 V - 33 kV; < 50 MWh/yr)	126	22.08	6.81	6.81
		Peak	Off-peak	Demand
	(\$/day)	(c/kWh)		(c/kWh/day)
Large Business Demand (S1) (low/medium voltage 240/415 V)	>=335.36	12.19	7.71	85.18
Large Business Demand (T1) (high voltage 6.6-33 kV)	>=442.42	11.4	7.58	77.95

### 2.3 Northern Territories

The electricity tariffs in the Northern Territories are integrated, bundled tariffs reflecting Power and Water Corporation's status as a vertically integrated monopoly generation and network services company. The Utilities Commission of the Northern Territory has reasoned that the small number of customers in NT does not warrant an unbundling of tariffs. Table 16 indicates the tariff design employed by Power and Water.



**Table 16. Network Tariff Design in the Northern Territories**

Data Source: Power and Water, NT Utilities Commission (2009)

	Cost Components	Customer Type (by consumption)	Cost Allocation	Rate Structure	Variations
<b>Integrated Bundled Tariff</b>	Connection assets, metering, administrative and commercial service	Large	Average	Fixed monthly (\$/month)	-
		Small	Average	Fixed daily (\$/day)	-
	Shared transmission and distribution network usage, network control, ancillary and other common services	Large customers only	Average by demand voltage level	Monthly capacity (\$/kVA/month)	Peak / off-peak
		Small customers only	Average	Included in fixed connection charge	-
	Energy	Large customers only	Consumption	Volume (\$/kWh)	Peak / off-peak
		Small customers only	Consumption	Volume (\$/kWh)	-

Large and small customers pay a fixed monthly (\$/month) and daily (\$/day) charge respectively based on the average cost of connection assets, meters, meter reading and other administrative and commercial services.

Large customers are charged for shared network usage in the form of a monthly demand charge (\$/kVA/month) which varies by peak and off-peak usage. Charges for demand decrease by increasing demand blocks. Small customers do not have demand charges. The demand charges act as an incentive for large customers to minimize their maximum demand. Small customers do not have such an incentive. By minimizing overall demand for each connection, network costs can be reduced through limited network expansion and smaller connection capacities.

Both large and small customers have an energy charge measured by consumption volume (\$/kWh), with peak / off-peak energy prices for large customers. Time of use pricing is not available to small customers. Large consumers can reduce their energy costs by consuming during off-peak periods when it is cheaper to produce and supply electricity. Decreasing block rates with increasing consumption have a negative incentive where customers can consume more at lower marginal costs of consumption.

No special arrangements are observed for renewable energy or distributed generation in the Northern Territory system. It therefore closely resembles traditional vertically integrated electricity systems in many parts of the world. In late 2009, a Full Retail Contestability (FRC) public consultation was conducted to evaluate the potential and scope of retail competition in the Northern Territories electricity system. However, the study committee concluded that the potential benefits of retail competition in the system are very small in the absence of significant restructuring of the system and reorganization of Power and Water Corp's asset network and generation assets. Pending further actions by the Northern territories legislature and the Utilities Commission, the tariffs in this system will therefore continue to be integral tariffs.

Table 17 describes the final integral tariff applicable to the “Northern Grid” sub-division in Northern Territories. Similar tariffs are applied in the “Alice Springs” and “Tennant Creek” sub-divisions.

**Table 17. Integral Tariff for the Northern Grid Sub-division (2009-10) (AUD 2009)**

Data Source: Power and Water, NT Utilities Commission (2009)

<b>A - For Customers with consumption above 750 MWh per year</b>					
Reference Service <sup>1</sup> Provided: Normal Transmission and Distribution of Electricity consumed through customer's metering for customers supplied and metered at any voltage in the Darwin and Katherine network areas.					
	<b>System Availability Charge</b>	<b>\$/kVA peak<sup>2</sup></b>	<b>\$/kVA off peak</b>	<b>c/kWh peak</b>	<b>c/kWh off peak</b>
<b>System Availability Charge</b>	Dollars per month				
		\$442.992			
<b>Plus charges related to monthly demand</b>					
	First 50 kVA per month	6.633	1.540		
	Next 100 kVA per month	5.753	1.364		
	Next 300 kVA per month	4.774	1.188		
	Next 500 kVA per month	3.762	1.056		
	Next 1,000 kVA per month	2.838	0.869		
	Any further kVA per month	2.574	0.781		
<b>Plus charges related to energy metered</b>					
	First 10,000 kWh per month			4.017	3.686
	Next 20,000 kWh per month			2.959	2.629
	Next 50,000 kWh per month			2.409	2.079
	Next 100,000 kWh per month			2.035	1.694
	Next 200,000 kWh per month			1.584	1.122
	Next 200,000 kWh per month			1.353	1.012
	Any further energy per month			1.232	0.891
<b>B - For Customers with consumption below 750 MWh per year</b>					
Reference Service <sup>1</sup> Provided: Normal Transmission and Distribution of Electricity for customers supplied at low voltage <sup>3</sup> in the Darwin and Katherine network areas.					
	<b>System Availability Charge</b>				<b>c/kWh anytime</b>
<b>System Availability Charge</b>	Commercial: cents per day	37.004			
	Domestic: cents per day	23.287			
<b>Plus charges related to energy metered</b>					
	First 1,000 kWh per month (pro-rated per billing period)				7.861
	Energy used above 1,000 kWh per month (pro-rated per billing period)				6.094
	Street lighting and other unmetered supplies				4.434

<sup>[1]</sup> Charges for increased or reduced service such as for higher reliability or for back-up supply to on-site generation are subject to negotiation.

<sup>[2]</sup> Peak and off-peak periods for demand and energy related charging rates will be as determined from time to time. The peak period rates currently apply to usage between 6.00 am and 6.00 pm on any day. Off-peak period rates apply at other times.

<sup>[3]</sup> If a customer requiring less than 750 MWh per year is supplied at high voltage, a discount of 5% applies to Energy rate charges only.

# PORTUGAL

Portuguese customers pay access tariffs that are comprised of both network and energy policy costs. The access tariffs are uniform across the entire country, with differentiations by voltage levels and time of use. The high degree of voltage and time of use differentiation allows the access tariffs to reflect the cost of providing network service to individual customers at their respective voltage level and times of use. However, the lack of geographical variation in tariffs distorts the cost allocation to various network users. Most customers in Portugal are on a Tariff of Last Resort, a regulated integral tariff. This arrangement is a policy choice that allows small customers, both residential and business, access to electricity at fixed prices. Medium and large customers can contract with retail suppliers for contract or negotiated rates. Regulated integral tariffs have resulted in under recovery of revenue requirements in recent years due to unexpectedly high energy costs and large payments to renewables and distributed generators. Such generators receive subsidies for network use through the Special Regime mechanism, in effect raising network related costs for end-use customers.

## 1. SYSTEM CHARACTERISTICS

The Portuguese electricity system is characterized by a high degree of restructuring. The wholesale market, transmission and distribution networks, and retail electricity supply are managed independently by legally separate entities.

### 1.1 Generation

The generation sector of the Portuguese electricity system operates under a wholesale market framework. The wholesale market is jointly managed with Spain as the Iberian Electricity Market (MIBEL). Daily and intra-daily transactions are managed by the Spanish partner, Operador do Mercado Ibérico de Energia - Pólo Español, S.A. (OMEL). The Portuguese partner, Operador do Mercado Ibérico de Energia - Pólo Português, S.A. (OMIP), manages the energy derivatives market. The MIBEL, or its individual operators OMEL and OMIP, do not own any generating capacity. Generators are primarily owned by independent power producers (IPPs) and distributed generators.

OMEL is the dispatcher and the billing agent for settlements between various market participants such as IPPs, Special Regime generators, distribution companies and retailers. Bilateral contracts between generators and customers are permitted, with any imbalances purchased in the spot market. The market is therefore a net pool. The spot market has day-ahead and real-time segments.



Figure 1. Portuguese Electricity System

Data Source: REN (2008)

The principal method of contracting electricity in Portugal is through transactions in the day-ahead market, which accounts for 85% of the energy contracted by volume. The balance is procured through long-term bilateral contracts (8%) and the intra-daily market (7%). EDP Serviço Universal, the largest retail supplier of electricity and the Provider of Last Resort, is the largest wholesale market customer and purchases about 98% of the electricity by volume. The costs of market operation are paid by all consumers connected to the electricity network in the form of dues included in the access tariffs.

The joint Iberian market facilitates the cross-border trade of electricity between the Portugal and Spain. It also has provisions for market splitting during peak hours when congestion conditions are experienced across the interconnections and during emergencies. An explicit market splitting fee is included in the access tariffs to pay for this service.

During the restructuring process most long-term power purchase agreements were ended to allow for the creation of the wholesale electricity market. However, two such agreements with the largest generators in Portugal, the Pego coal plant and the Turbogás combined cycle gas plant were preserved. A separate regulated entity, the Redes Energéticas Nacionais (REN) Trading Group manages these contracts. It also participates in the trading of energy securities in the OMIP and manages Portuguese emissions trading activities in the European emissions market. The revenue requirements for REN Trading and the stranded costs of the old power purchase agreements are recovered through the access tariffs.

REN Trading also procures ancillary services such as reserves, black start capability and voltage and frequency regulation through the MIBEL. The cost of ancillary services is included in the access tariffs to customers.

Table 1 displays the generation sector profile in Portugal. The generation capacity is divided into two categories: Ordinary Regime (70%) and Special Regime (30%). Large-scale hydroelectric plants represent the largest share of total generation capacity (30%), followed by wind (17.6%) and natural gas (14.5%). About 85% of the Ordinary Regime generation capacity is owned by EDP Produção, a subsidiary of the Energias de Portugal Group. Large-scale renewable generators and distributed generators are subject to the Special Regime, which comprises 30% of the total generating capacity. These generators receive special tariffs and premiums.

The Special Regime (PRE) is a mechanism to enable the achievement of targets for the penetration of renewable generation technologies and combined heat and power (CHP) applications in the Portuguese electricity system. The main characteristic of the PRE is the provision of financial premiums to certain generation technologies, as an incentive to enter the market and deliver electricity at desired levels of reliability and quality.

**Table 1. Generation Sector Profile in Portugal (2008)**

Data Source: ERSE, REN (2009)

<b>Fuel Source</b>	<b>Nameplate Capacity (MW)</b>	<b>Percentage Capacity</b>
<b>Ordinary Regime</b>		
Hydroelectric	4,578	30.7%
Coal	1,776	11.9%
Fuel-oil	1,476	9.9%
Fuel-oil / natural gas	236	1.6%
Gas-oil	165	1.1%
Natural gas	2,166	14.5%
<b>Sub-total</b>	<b>10,397</b>	<b>69.7%</b>
<b>Special Regime</b>		
Small hydroelectric	379	2.5%
Thermal	1,463	9.8%
Wind	2,624	17.6%
Photovoltaic	50	0.3%
Wave	2	0.0%
<b>Sub-total</b>	<b>4,518</b>	<b>30.3%</b>
<b>Total</b>	<b>14,915</b>	<b>100%</b>

The primary technology categories included in the Regime and their respective tariffs are listed in Table 2. Many PRE generators connect to the network at distribution voltage-levels as distributed generators, due to their small generating capacity. The distribution system operator is required to enter into connection agreements with qualifying generators, pursuant to specific technical and operating requirements. Some larger facilities are eligible to connect directly to the transmission network. PRE generators are entitled to transfer all of the electricity generated to the network, net of their consumption. These generators also enjoy priority of access and connection to the grid. That is, PRE generators are connected to the grid before other generators in the queue, and any net transfer by such generators must be accepted before other generators in that region of the network are dispatched. When these generators have fulfilled the technical and operating requirements as specified in their connection agreements with network companies, they receive the appropriate regulated tariff or the wholesale market price, and a premium in some cases. PRE generators can also sell electricity to consumers through a direct connection and bilateral contracts, and are not required to sell to the grid or in the wholesale market. Costs corresponding to PRE payments are recovered from all consumers connected to the network through access tariffs. As Figure 2 indicates, the average cost of electricity from PRE generators has been significantly higher than average costs of energy acquired from the ordinary regime generators.

**Table 2. Description and Reference Tariffs of the Special Regime for Generation**

Data Source: Portuguese Director General of Energy and Geology (2009)

Technology	Reference Rate (€/MWh)	Terms
Wind	74 - 75	33 GWh/MW or 15 years
Hydro (< 10 MW)	75 - 77	52 GWh/MW or 20 years, in some cases 25 years
Photovoltaic (> 5 kW)	310 - 317	21 GWh/MW or 15 years
Photovoltaic (<= 5 kW)	450	
Solar Thermal (<= 10 MW)	267 - 273	
PV Microgeneration (<= 5 kW)	470	
PV Microgeneration (> 5 kW and <= 150 kW)	355	
Biomass	102 - 109	15 years
Biogas	102 - 117	25 years
Agricultural waste	53 - 76	15 years
Waves (< 4 MW)	260	15 years
Waves (< 20 MW)	191	15 years
Waves (>=100 MW)	131	15 years

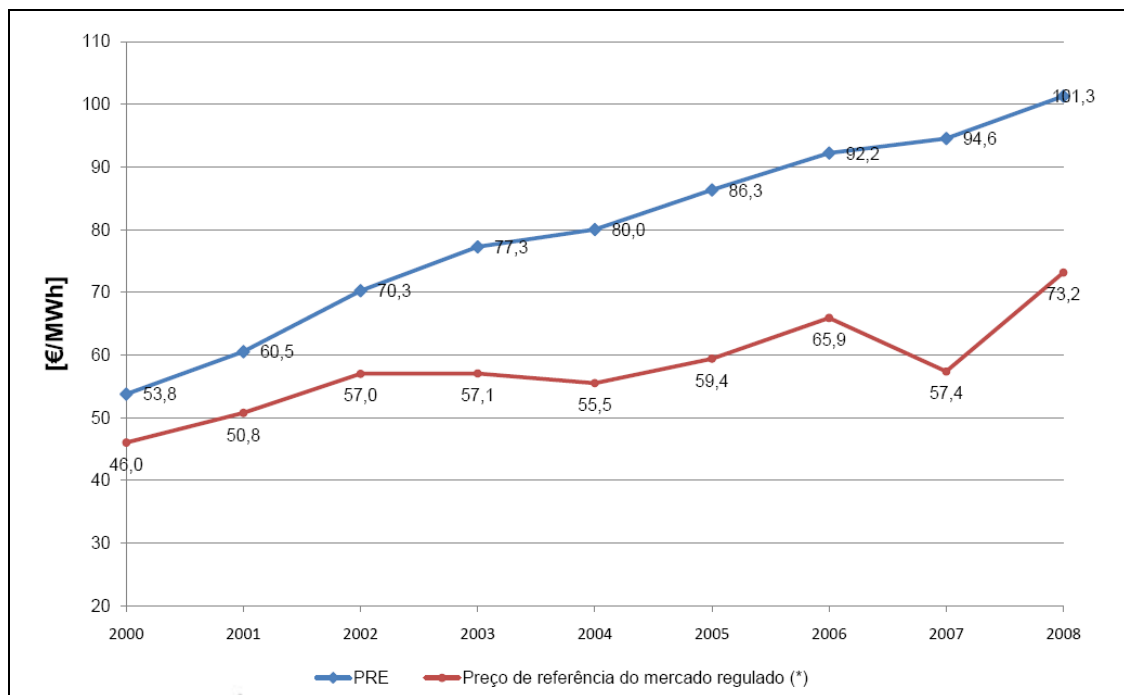

**Figure 2. Average Wholesale Electricity Costs in Portugal (2000-2008)**

Source: ERSE (2009)

## 1.2 Networks

The transmission network in Portugal is owned and operated as a single national network. Distribution networks are owned by more than one entity but operated by one distribution operator. Both networks are regulated by the Portuguese energy regulator, Entidade Reguladora Dos Serviços Energéticos (ERSE).

Redes Energéticas Nacional, SA (REN) is the national transmission system operator (TSO). It has exclusive concessionary rights to own and operate the transmission system until 2057. The holding company Redes Energéticas Nacionais SGPS owns 100% of REN along with the national natural gas transmission system, telecommunication assets, and the REN Trading Corporation. Approximately 50% of the holding company is owned by the Portuguese state, while 30% is owned by other large state-owned and private corporations including RED Eléctrica and EDP Group. Small shareholders own the remaining 20% of the REN Group.

**Table 3. Transmission Line Lengths and Investments (2005 – 2008)**

Data Source: REN, ERSE (2009)

Voltage (kV)	2005	2006	2007	2008
	Line Lengths (km)			
400	1,500	1,507	1,588	1,589
220	2,875	3,080	3,177	3,257
150	2,282	2,431	2,661	2,667
<b>Total</b>	<b>6,657</b>	<b>7,018</b>	<b>7,426</b>	<b>7,513</b>
	Investments (thousand €)			
<b>Total</b>	172,583	209,370	222,471	236,403

The transmission line lengths and investments in the network for the period 2005 – 2008 are summarized in Table 3. In 2008, Portugal's national transmission system consisted of approximately 7,500 km of transmission lines. The density of 220 kV lines is high around the main load centers of Lisbon and Porto. Most 400 kV transmission lines run North-South along the coast, with some East-West interconnections to Spain. Figure 3 depicts the transmission interconnections of varying capacities between Portugal and Spain. The regulated asset base of the Portuguese transmission network was estimated at € 1.67 billion



in 2008. REN's annual revenue requirements are set by ERSE, and recovered through the access tariffs, as shown in Table 5.

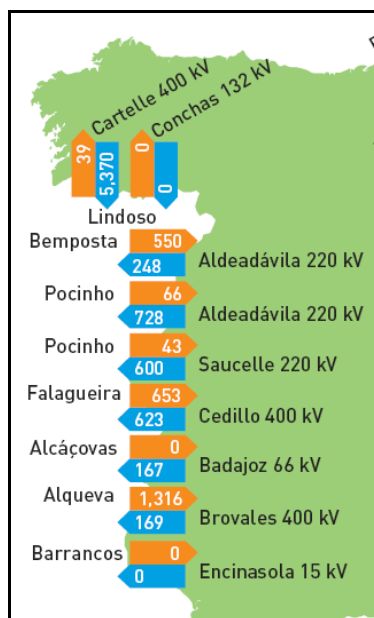

Figure 3. Transmission Interconnections to Spain

Source: RED Eléctrica (2009)

Table 4. Distribution Line Lengths and Investments (2005 – 2008)

Data Source: EDP, ERSE (2009)

Voltage (kV)	2005	2006	2007	2008
	Line Lengths (km)			
60 kV	7,362	7,877	8,047	8,373
10 - 30	55,240	56,121	56,965	57,700
< 10	100,380	101,537	102,474	103,248
<b>Total</b>	<b>162,982</b>	<b>165,535</b>	<b>167,486</b>	<b>169,321</b>
	Investments (thousand €)			
<b>Total</b>	332,355	282,943	239,812	242,574

REN plans to invest approximately € 1.8 billion during the period 2009 to 2014 for grid reinforcements (18%), network expansion (29%), interconnection capacity augmentation (12%), new customer connections (12%), new distributed generation connections (12%), large-scale generator connections

(13%), and supporting equipment (4%). Once the investments have been approved by ERSE, the investments are added to the rate base and REN recovers the cost of new investments through the annual revenue requirements. Thus, there exists a due process for new transmission investments and allocation and recovery is not an issue once new investments have been approved. The decision of investment approval is left to ERSE.

The distribution networks in Portugal are owned by a large network company and some small electricity cooperatives. EDP Distribuição, a subsidiary of the EDP Group, owns approximately 99% of the national distribution network, and therefore serves as the Distribution System Operator (DSO). The other owners are required to sign agreements with the DSO, allowing it to manage and operate their networks. The distribution network line lengths and investments undertaken by EDP Distribuição for the period 2005 – 2008 are summarized in Table 4. The DSO's annual revenue requirements are set by ERSE, and recovered through the access tariffs as shown in Table 5.

**Table 5. Annual Revenue Requirements (ARR) for Regulated Electricity Companies (2010)**

Data Source: EDP, REN, ERSE (2009)

<b>REN Trading</b>	<b>248,060</b>
Energy Procurement	248,060
<b>REN</b>	<b>803,574</b>
Global System Management	543,626
Transmission costs	259,948
<b>EDP Distribuição</b>	<b>2,573,875</b>
Distribution costs	1,245,404
Transmission access	1,328,471
<b>EDP Serviço Universal</b>	<b>4,001,219</b>
Premiums to Special Regime	805,123
Regular purchases	949,423
Transmission and distribution access	2,145,826
Commercial services	100,847
<b>Energy and network services in Azores</b>	<b>170,626</b>
<b>Energy and network services in Madeira</b>	<b>188,533</b>

Table 5 summarizes the annual revenue requirement of different regulated agents in the Portuguese electricity industry. REN Trading recovers costs associated with its energy securities trading in the OMIP and procurement of energy related services. Through the Global Use of System charges (UGS), REN recovers costs corresponding to transmission system operation, scheduling and dispatch, ancillary services, market operation dues (OMEL and OMIP), ERSE operating costs, stranded costs of old power purchase agreements and energy efficiency programs. In general, the UGS costs are those that relate to energy policy. EDP Distribuição is paid for the costs of operating the distribution network as well as payments to REN for transmission access. As the retail supplier, EDP Serviço Universal recovers energy costs, in addition to both transmission and distribution access. Thus, costs incurred by REN Trading, REN and EDP Distribuição are eventually passed through to end-use customers in the access tariffs paid to EDP Serviço Universal.

## **2. TARIFFS**

Portugal has two distinct tariff designs: Tariffs of Last Resort (ToLR) and retail tariffs, although the retail tariffs are identical to the Tariffs of Last Resort for most small and medium customers.

The Tariff of Last Resort is a regulated integral tariff comprised of the energy, energy policy and network-related costs. Competitive retail tariffs also include the regulated charges for network-related costs and some energy policy costs, but the other components are influenced by the retail market. In Portugal, the tariff components that pertain to the network-related costs and the regulated energy policy costs are collectively called “access tariffs,” as they represent the costs incurred upon accessing the network. The term access tariff will therefore be used hereafter, instead of “network tariff.”

The most important characteristic of the access tariffs in Portugal is that they are uniform across the entire country. They are differentiated by voltage category, but not by geographical location. This characteristic introduces economic distortions in network cost allocation because network access in some regions is subsidized by consumers in others. However, the access tariffs are differentially allocated across many voltage levels. The charges therefore closely reflect the cost of delivering network services to customers connected at each of these voltage levels.

The Portuguese regulator ERSE annually publishes detailed documents that provide information about the cost allocation formulas and methodology it uses to calculate the access tariffs and Tariffs of Last Resort. ERSE also conducts public consultations on its annual tariff proposals. The rate setting process is thus transparent and open to public scrutiny.

## 2.1 General Tariff Design

Table 6 describes the general tariff architecture for the Portuguese access tariffs, for both transmission and distribution networks, and energy policy costs.

**Table 6. General Tariff Design in Portugal**

	Cost Components	Customer Type (by consumption)	Cost Allocation	Rate Structure
<b>Connection Charges</b>	Connection assets; Network reinforcement	Generator	Dedicated (deep)	Fixed monthly (€/month) and daily (€/day)
		Large	Average by voltage category	Fixed monthly (€/month) and daily (€/day)
		Medium	Average by voltage category	Fixed monthly (€/month) and daily (€/day)
		Small	Average by voltage category	Fixed monthly (€/month) and daily (€/day)
		Very small	Average by voltage category	Fixed monthly (€/month) and daily (€/day)
		Distributed Generator	Dedicated (deep)	Fixed monthly (€/month) and daily (€/day)
<b>Distribution UoS Charges</b>	Shared network use; Common services like system control; Administrative costs of network operation	Large	Average by voltage category and capacity	Monthly capacity (€/kW/month) and volume (€/kWh)
		Medium	Average by voltage category and capacity	Monthly capacity (€/kW/month) and volume (€/kWh)
		Small	Average by voltage category and capacity	Monthly capacity (€/kW/month) and volume (€/kWh)
		Very small	Average by voltage category and capacity	Monthly capacity (€/kW/month) and volume (€/kWh)
		Distributed Generator	Only when consuming	As above
<b>Transmission UoS Charges</b>	Shared network use; Common services like ancillary services; Administrative costs of network operation	Generator	None	None
		Large	Postage stamp	Monthly capacity (€/kW/month) and volume (€/kWh)
		Medium	Postage stamp	Monthly capacity (€/kW/month) and volume (€/kWh)
		Small	Postage stamp	Monthly capacity (€/kW/month) and volume (€/kWh)
		Very small	Postage stamp	Monthly capacity (€/kW/month) and volume (€/kWh)
<b>Commercial Services</b>	Meter installations and reading; billing services	All	Average	Fixed monthly (€/month) and daily (€/day)
<b>Energy Policy</b>	Renewable Energy	All	Average by voltage category and capacity	Fixed monthly (€/month) and daily (€/day)
	Others	All	Average by voltage category and capacity	Fixed monthly (€/month) and daily (€/day)

All network users in Portugal pay connection charges, which differ by customer category. Generators and distributed generators pay dedicated or deep connection charges that include costs for direct connection

to the network and network reinforcements. Charges are in the form of a capacity charge (€/kW/year). End-users are responsible for an average connection charge that is inclusive of direct connection costs and network reinforcements, and depends on their voltage category. Small and very small customers pay fixed monthly (€/month) and daily charges (€/day). Medium and large customers pay monthly capacity (€/kW/month) and daily capacity (€/kW/day) charges. Connection charges influence siting decisions for generators in the Portuguese system because such users are responsible for deep charges. Most end-use consumers are not affected because they pay a charge that is a system-wide capacity-weighted average.

Distribution Use-of-System charges are calculated by voltage level. ERSE uses detailed formulas to determine network usage and allocate costs at each voltage level. Small customers pay fixed monthly (€/month) and daily charges (€/day), and also a charge that varies by consumption volume (€/kWh). At higher voltage levels, customers pay a capacity-weighted average charge based on the voltage level to which they are connected. Medium and large customers pay fixed monthly and daily capacity charges (€/kW/month and €/kW/day) and also by consumption volume (€/kWh). Distributed generators do not pay for network use.

Transmission Use-of-System charges are also calculated as an average across all transmission level customers, weighted by their capacity. The average charge is, in effect, a postage stamp rate because of a single transmission network across the entire country. Transmission level charges for network use are passed through to end-use customers in the final access tariff. These charges appear in the form of a fixed monthly and daily capacity charge (€/kW/month or €/kW/day), and a charge that varies by consumption volume (€/kWh). Generators do not pay use for network use. As a result, the cost of network usage does not influence generator's siting decisions. Even if generators were to pay for network usage, the postage stamp rate would not provide a locational signal for the cost of network services at the transmission level. However, congestion costs included in the wholesale energy price will partly influence generators' siting decisions.

Charges for commercial services such as meter reading, billing and other administrative expenses are calculated as an average across all customers connected to the electricity system. Such charges are recovered through a fixed monthly charge (€/month), fixed daily charge (€/day) and volume charge (€/kWh), which are added to the other fixed monthly connection and Use-of-System charges.

All customers connected to the network are responsible for a number of fixed charges designed to recover costs related to energy policy (UGS charges) as summarized in Table 5. Such charges are passed through to customers in the form of fixed monthly (€/month) and daily (€/charges), and added to the charges discussed above.

## 2.2 Rate Design

ERSE calculates and publishes the final rates for Tariffs of Last Resort, which are updated annually. EDP Serviço Universal (EDP SU) is the main ToLR supplier in Portugal, along with small independent cooperatives. Table 7 and 8 lists final ToLR rates for selected customer categories, as offered by EDP SU. Residential and business customers of all sizes qualify for regulated ToLR rates. Customers sign an annual contract with EDP SU and are charged fixed monthly and daily charges (€/month and €/day) and energy charges (€/kWh) based on the volume of electricity consumed. Two-period and three-period time-of-use options with peak and off-peak rates are available to small customers. Large customers are placed on time-of-use tariffs with seasonal variations. All customers are placed on ToLR service unless they choose to contract with a retail supplier.

Two tariff categories within the ToLR are designed for special consumer groups. Small residential customers in low-income groups or senior citizens may qualify for the “Social Tariff,” a subsidized tariff under the ToLR arrangement for connections at 1.15 kV below. Such customers pay reduced fixed monthly and daily charges (€/month and €/day) and volume-based energy charges (€/kWh). Small residential customers connected at 2.30 kVA are not eligible for the subsidized rate and are offered the Standard Tariff, but have an identical charge structure. The Social Tariff and the Standard Tariff are only available to residential customers.

Medium and large customers that are on ToLR see the rate structure shown in Table 8. The tariffs for customers connected at very high voltage levels (> 110 kVA) are used as an example. Connection charges are in the form of monthly and daily capacity charges (€/kW/month and €/kW/day). The volume-based energy charges (€/kWh) are differentiated by time-of-use into three daily periods and four seasons. Medium and large customers are also required to pay separate charges per unit of reactive power drawn from the network (€/kVArh). On the other hand, they are paid if they supply more reactive power than they consume.

Customers who are not on a ToLR arrangement can contract for retail supply from EDP Comercial, or another supplier such as Iberdrola, Endesa or Union Fenosa. The distribution company, EDP Distribuição, continues to serve as the billing agent. ERSE publishes the access tariffs for customers who choose to procure energy from retail suppliers, as shown in Table 9. Selected customer categories are displayed to gain an understanding of the rate structure, which is identical to the ToLR rate structures shown in Tables 7 and 8.

**Table 7. Tariffs of Last Resort for Low Voltage Customers in Portugal (2009)**

Data Source: ERSE, EDP Serviço Universal (2009)

Voltage Category	Voltage	Fixed Monthly Charge		Fixed Daily Charge		Energy Charge			
	(kVA)	(€/month)		(€/day)		(€/kWh)			
Normal Low Voltage (Social Tariff)	1.15	0.51		0.017		0.115			
	2.30	1.02		0.034		0.115			
Normal Low Voltage (Standard Tariff)	1.15	2.05		0.068		0.115			
	2.30	4.09		0.135		0.115			
Normal Low Voltage (2.3 to 20.7 kVA)		Single Rate	Time of Use	Single Rate	Time of Use	Peak	Flat	Off-peak	
	3.45	5.65	7.76	0.186	0.255	Single Rate	0.121		
	10.35	15.44	14.35	0.508	0.472	Two-period	0.123	0.066	
	20.70	29.93	39.44	0.984	1.297	Three-period	0.136	0.120	0.066
Normal Low Voltage (> 20.7 kVA)		Average	High	Average	High	Peak	Flat	Off-peak	
	27.60	51.33	209.74	1.687	6.895	Average use	0.241	0.109	0.059
	41.40	76.45	314.54	2.513	10.341	High Use	0.145	0.083	0.054

**Table 8. Tariffs of Last Resort for Very High Voltage Customers in Portugal (2009)**

Data Source: ERSE, EDP Serviço Universal (2009)

<b>Fixed Charges</b>	(€/month)	(€/day)		
	73.68	2.423		
<b>Fixed Capacity Charges</b>	(€/kW/month)	(€/kW/day)		
Peak	4.364	0.144		
Contracted	0.546	0.018		
<b>Energy Prices</b>	(€/kWh)			
Season	Peak	Flat	Off-peak	Very low
I	0.078	0.059	0.038	0.036
II	0.079	0.062	0.041	0.038
III	0.079	0.062	0.041	0.038
IV	0.078	0.059	0.038	0.036
<b>Reactive Power</b>	(€/kVArh)			
Supplied	0.016			
Drawn	0.012			

The high degree of differentiation in access tariffs by voltage category and time of use reflects the cost of providing network services at various voltage levels, and times of the day and year. Moreover, the ToLR rates are also good indicator of the cost differences, because the ToLR rate structure is identical to that of the access tariffs, which are passed through. The charges for reactive power provide medium and large customers with the incentive to maintain their load at a high power factor by reducing the amount of reactive power drawn from the network. They are also paid if they can supply reactive power to the grid, which increase the power quality in the network.

**Table 9. Access Tariffs for Selected Customer Categories (2009)**

Source: ERSE (2009)

Small Low Voltage Customers (<=2.3 kVA)		Rates	
Fixed		(€/month)	(€/day)
Social	1.15	1.09	0.0360
Standard	2.3	2.19	0.0719
Energy		(€/kWh)	
Social/Standard		0.0294	

Low Voltage Customers (>= 27.6 kVA)		Rates	
Fixed		(€/month)	(€/day)
	27.6	26.25	0.8629
	34.5	32.81	1.0787
	41.4	39.37	1.2944
Energy		(€/kWh)	
	Peak	0.1392	
	Flat	0.0332	
	Off-peak	0.0067	

Very High Voltage Customers (>110 kVA)		Rates	
Fixed		(€/kW/month)	(€/kW/day)
	Peak	1.125	0.0370
	Contracted	0.361	0.0119
Energy		(€/kWh)	
Períodos I, IV	Peak	-0.0029	
	Flat	-0.0029	
	Off-peak	-0.0031	
	very low	-0.0030	
Períodos II, III	Peak	-0.0029	
	Flat	-0.0029	
	Off-peak	-0.0030	
	very low	-0.0030	
Reactive Power		(€/kVArh)	
	Supplied	0.0161	
	Drawn	0.0120	



## 2.3 ToLR Distortions

Integral tariffs like the Tariffs of Last Resort may introduce significant distortions in the economic performance of the electricity industry because the incurred costs may be significantly higher than the annual revenue requirements originally approved. Consequently, the regulated rates may not always be sufficient to recover the incurred costs. In most cases, annual settlements are sufficient to reconcile any deviations of the incurred costs from the expected revenue requirements, with minor rate impacts in subsequent years. However, the distortion is acute when the realized costs deviate significantly from the expected costs in a given year, and the deviations cannot be settled in the following annual review period due to significant rate impacts. The energy cost component of the regulated ToLR is prone to such deviations because the rate does not reflect the volatility in the costs of energy procured in the wholesale electricity market. The ToLR rates thus lock-in an expected price of energy. In the competitive retail sector, energy prices are passed through to customers in each billing cycle, through which retailers can recover their energy costs. The distortion is therefore limited to the regulated tariff segment of the industry, affecting the regulated entities operating in that segment. In Portugal, such a distortion was observed between the years 2007 and 2009 when the realized energy costs were much higher than expected. For the sake of illustration, the deviation between the revenue review periods for 2008 and 2009 is depicted in Figure 4.

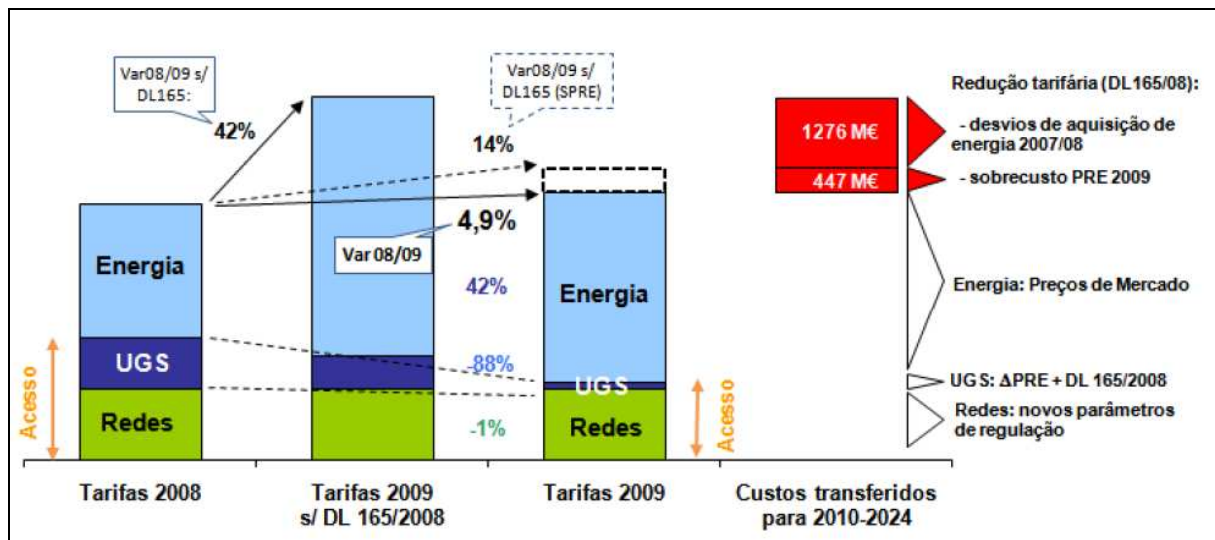

Figure 4. Access Tariffs for Selected Customer Categories (2009)

Source: ERSE (2009)

Between the end of 2007 and 2008, the energy costs incurred by the providers of ToLR increased by 42% (Energia), whereas the network-related costs (Redes) were stable, and a small decrease was realized in the general system operation costs (UGS). The energy cost increase can be attributed to high

wholesale market prices (deficit of € 1,276 million), exacerbated by large payments to Special Regime generators (deficit of € 447 million). The tariffs for 2009 were revised by introducing a tariff deficit to defer cost recovery, instead of settling the cost increase the following year. The tariff deficit was a policy mechanism to avoid a large rate impact, which was politically and socially undesirable. Consequently, the aggregate increase in expected ToLR revenues was only 14% over the 2008 tariffs. The deficit was introduced in the access tariff component of the ToLR revenue requirements, to enable the regulated network companies and providers of ToLR to make payments to regular and Special Regime generators for the energy services procured. The mechanism thus resulted in incomplete cost recovery on the part of the regulated network companies that would have recovered their costs through the access tariffs. The deficit was subsequently securitized as long-term debt, to be recovered by the network companies between 2010 and 2024. Although the deficit mechanism will result in eventual reconciliation of costs incurred by the system, it is not a long-run solution to avoid future economic distortions as a consequence of regulated integral tariffs.

The effects of the economic distortion introduced by the regulated ToLR due to high energy costs are evidenced in part by the trend of customer switching from retail to regulated tariffs. While the retail energy prices rose as a consequence of high energy costs, ToLR rates stayed relatively constant. The network-related costs were relatively stable as shown in Figure 4. As a consequence, many customers in Portugal that had switched from regulated tariffs to competitive retail contracts during the course of restructuring began to switch back to ToLR between 2006 and 2008. Switching was most significant in the medium and large voltage categories, i.e. categories with high energy consumption. Figure 5 depicts this trend graphically. Values of consumption for each customer category are summarized in Table 10.

As described above, Special Regime payments to large-scale renewables and distributed generators contributed significantly to the dramatic increase in energy costs (€ 447 million). The regulated tariffs and premiums under the SR are therefore a costly incentive to such generators. Distributed generators, in particular, receive special rates for the net metered electricity supplied, as described in Table 2. When such generators consume more electricity than they generate, they are charged according to the appropriate customer category for the net electricity consumed. On the other hand, they receive payments when they supply surplus electricity back to the distribution network. In many cases, the special tariff rate used is higher than the final ToLR rate or retail tariff rate. Furthermore, payments to distributed generation under the SR are recovered from all customers through the access tariff. Such generators therefore receive a subsidy for being connected to the system – in effect, they are paid for using the network when they supply net-metered electricity to the grid, and the corresponding costs of network use are borne by end-use customers.

Table 10. Electricity Consumption under ToLR and Retail Tariffs (2004 - 2008)

Source: ERSE (2009)

Voltage Level	Electricity Consumption (GWh)				
	2004	2005	2006	2007	2008
<b>Regulated Tariffs</b>					
Very high	1,224	1,278	1,394	1,527	1,667
High	4,345	5,153	5,361	6,265	6,358
Medium	6,522	5,105	8,603	10,290	14,052
Low	18,126	19,024	19,235	19,523	18,364
Special	3,159	2,351	2,312	2,491	3,340
<b>Sub-total*</b>	<b>34,594</b>	<b>34,211</b>	<b>38,304</b>	<b>41,546</b>	<b>45,289</b>
<b>Competitive Retail Supply</b>					
Very high	-	37	41	3	-
High	49	144	98	11	2
Medium	6,680	8,489	5,820	4,098	263
Low	-	-	13	264	695
Special	33	950	1,190	996	219
<b>Sub-total</b>	<b>6,763</b>	<b>9,621</b>	<b>7,161</b>	<b>5,373</b>	<b>1,180</b>
<b>Total</b>	<b>41,357</b>	<b>43,832</b>	<b>45,465</b>	<b>46,919</b>	<b>46,469</b>

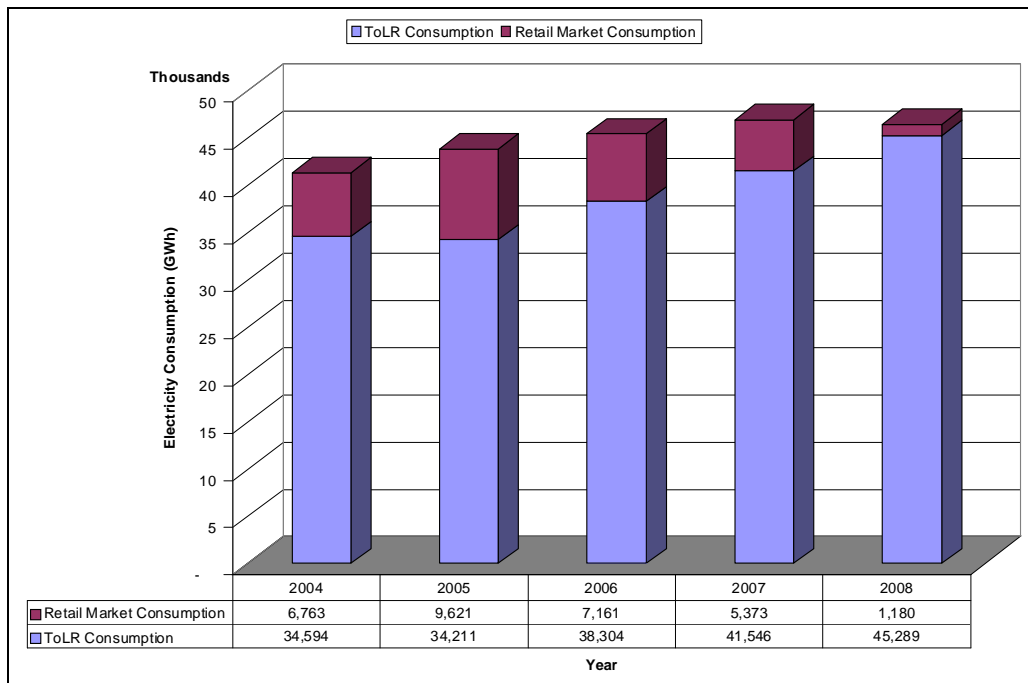

Figure 5. Aggregate Electricity Consumption under ToLR and Retail Tariffs (2004 - 2008)

Source: ERSE (2009)

## SPAIN

Most customers in Spain are on a Tariff of Last Resort, a regulated integral tariff. This arrangement is a policy choice that allows small customers, both residential and business, access to electricity at fixed prices. Medium and large customers can contract with retail suppliers for contract or negotiated rates. Spanish customers pay access tariffs that are comprised of both network and energy policy costs, about half the cost of which can be attributed to the latter. Moreover, the tariffs are uniform across the entire country, with differentiations only by voltage levels and time of use. The inclusion of large energy policy costs and the lack of geographical differentiation do not allow the access tariffs to reflect the cost of providing network service to individual customers. Furthermore, distributed generators receive subsidies through the Special Regime mechanism, in effect raising access costs for end-use customers.

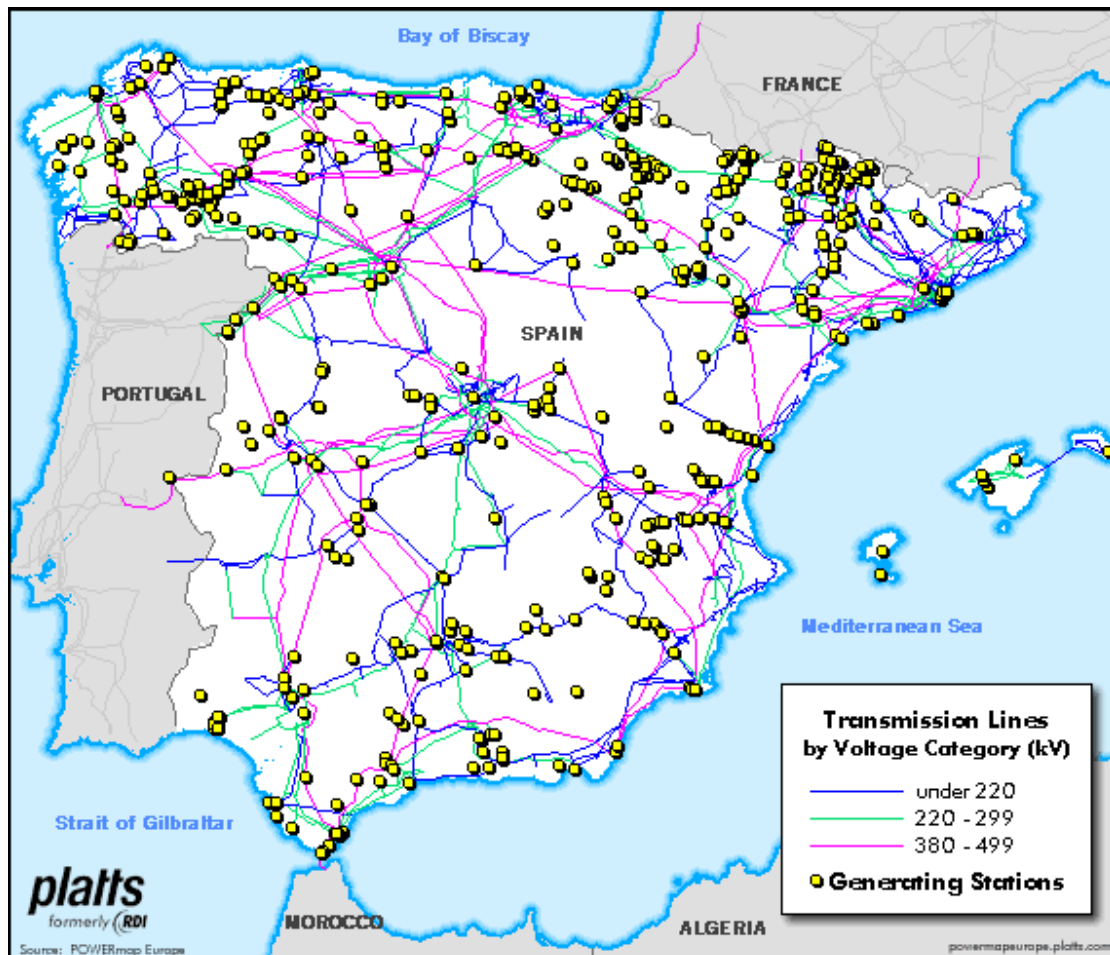

Figure 1. Spanish Electricity System (GENI 2009)

# 1. SYSTEM CHARACTERISTICS

The Spanish electricity system is characterized by a high degree of restructuring. The wholesale market, transmission and distribution networks, and retail electricity supply are managed independently by legally separate entities.

## 1.1 Generation

The generation sector of the Spanish electricity system operates under a wholesale market framework. Operador del Mercado Ibérico de Energía – Polo Español, S.A. (OMEL), a not-for-profit corporation instituted in 1997, is the wholesale market operator. OMEL does not own any generating capacity. Generators are primarily owned by independent power producers (IPPs) and distributed generators.

OMEL is the market operator and the billing agent for settlements between various market participants such as IPPs, Special Regime generators, distribution companies and retailers. Bilateral contracts between generators and customers are permitted, with any imbalances purchased in the spot market. The market is therefore a net pool. The spot market has day-ahead and real-time segments. The costs of market operation are paid by all consumers connected to the electricity network in the form of dues included in the access tariffs. OMEL procures ancillary services such as black start capability and voltage and frequency regulation through parallel ancillary services markets. The cost of ancillary services is included in the energy prices to consumers. Payments to ancillary services providers are made through monthly and annual settlement processes.

OMEL coordinates its operations with the Portuguese market operator OMIP to enable the functioning of the Iberian market which is comprised of Portugal and Spain. The joint Iberian market facilitates the cross-border trade of electricity between the two countries. It also has provisions for market splitting during peak hours when congestion conditions are experienced across the interconnections and during emergencies. An explicit market splitting fee is included in the access tariffs to pay for this service.

Peaking and reserve capacity is procured through a capacity payment system, where generators are paid regulated prices to be available during peak hours. The prices for capacity payments are included in the access tariffs and recovered from all customers in the system.

Table 1 displays the profile of the generation sector. Combined cycle gas plants represent the largest share of generation capacity (24%), followed by wind (19%) and hydroelectric power (17%). Large-scale renewable generators and distributed generators are subject to a Special Regime within the market, as discussed below. These technologies collectively contribute about 33% of the generation capacity in Spain and receive special tariffs and premiums.

**Table 1. Generation Sector Profile in Spain**

Data Source: OMEL, RED Eléctrica (2009)

Fuel Source	Nameplate Capacity (MW)	Percentage Capacity
Hydro	16,658	17%
Nuclear	7,716	8%
Coal	11,869	12%
Oil/Gas	6,907	7%
Combined Cycle	23,635	24%
Wind	18,263	19%
Solar	3,729	4%
Other renewables	9,725	10%
<b>Total</b>	<b>98,502</b>	<b>100%</b>

The Special Regime (SR) is a mechanism to enable the achievement of targets for the penetration of renewable generation technologies and combined heat and power (CHP) applications in the Spanish electricity system. The main characteristic of the SR is the provision of financial premiums to certain generation technologies, as an incentive to enter the market and deliver electricity at desired levels of reliability and quality.

**Table 2. Description and Examples of the Special Regime for Generation**

Data Source: Royal Decree 661/2007 (2009)

Category	Application	Principal Fuels	Technology Example	Tariffs and Premiums (c€/kWh)	
				Tariffs	Premiums
<b>a.</b>	Combined Heat and Power (CHP)	Natural gas, Liquefied Petroleum Gas (LPG), biomass or biogas, other fossil fuels including coal and oil	Liquefied Natural Gas 1 < Capacity < 10 MW	9.62	4.03
<b>b.</b>	Renewable generation	Photovoltaic and solar thermal, wind, geothermal, bio-waste, hydro-electric (less than 10 MW, between 10 and 50 MW)	Photovoltaic Capacity < 10 kW (for the first 25 years)	47.02	-
<b>c.</b>	CHP or renewable generation	Wastes and residues produced by applications in categories (a) and (b)	Solid urban waste	5.36	2.75

The primary technology categories included in the Regime are listed in Table 2. Many SR generators connect to the network at distribution voltage-levels as distributed generators, due to their small generating capacity. Distribution companies are required to enter into connection agreements with qualifying generators, pursuant to specific technical and operating requirements. Some larger facilities are also eligible to connect directly to the transmission network. Such generators are entitled to transfer all of the electricity generated to the network, net of their consumption. These generators also enjoy

priority of access and connection to the grid. That is, Special Regime generators are connected to the grid before other generators in the queue, and any net transfer by such generators must be accepted before other generators in that region of the network are dispatched. When these generators have fulfilled the technical and operating requirements as specified in their connection agreements with network companies, they receive the appropriate regulated tariff or the wholesale market price, and a premium in some cases. SR generators can also sell electricity to consumers through a direct connection and bilateral contracts, and are not required to sell to the grid or in the wholesale market. Table 2 also includes selected examples of the regulated tariffs and premiums received by some typical categories of SR generators. Costs corresponding to Special Regime payments are recovered from all consumers connected to the network through “access tariffs,” as discussed later.

## 1.2 Networks

The transmission network in Spain is operated as a single national network, although several entities own transmission assets. Distribution networks are owned and operated by separate distribution companies.

RED Eléctrica is the national transmission system operator (TSO). It has exclusive concessionary rights to own and operate the transmission system. Pursuant to restructuring laws, all transmission owners were required to transfer transmission assets to RED Eléctrica for ownership and operation under its exclusive license. Thus, most of the transmission network assets are now owned and managed by RED Eléctrica. However, some entities still own a small share of the transmission network. The other transmission owners are distribution companies with high voltage assets in their grids. These distribution networks are required to sign agreements with RED Eléctrica, allowing it to operate their high voltage assets as part of the transmission network. The RED Eléctrica Corporation is a holding company, of which 20% is owned by the state. The majority share is owned by other private Spanish institutions (26%), minority shareholders (7%), and foreign institutions (47%). The Corporation also owns a 5% state in the Portuguese transmission system REN, in addition to international telecommunications and finance business. The network line lengths and new investments in the transmission network undertaken by RED Eléctrica for the period 2005 – 2009 are summarized in Table 3. The annual revenue requirements (ARR) for the transmission owners are listed in Table 4. The ARR for each company is approved by the Spanish National Energy Commission (Comisión Nacional de Energía, CNE) and submitted to the Ministry of Industry, Tourism and Commerce (MITC) for inclusion in the access tariff calculation. RED Eléctrica's share is 85% of the transmission network in terms of line length, and 93% in terms of ARR.

**Table 3. Transmission Line Lengths and Investments (2005 – 2009)**

Data Source: RED Eléctrica (2009)

<b>Voltage</b>		<b>Line Length (kilometers)</b>				
<b>Spanish Mainland</b>		2005	2006	2007	2008	2009
400 kV	RED Electrica	16,808	17,005	17,134	17,686	17,988
	Others	38	38	38	38	38
200 kV or below	RED Electrica	16,288	16,498	16,535	16,637	16,771
	Others	245	261	266	273	276
<b>Islands</b>						
220 kV or below	RED Electrica and Others	2,192	2,185	2,309	2,330	2,343
<b>Total</b>		<b>35,571</b>	<b>35,987</b>	<b>36,282</b>	<b>36,964</b>	<b>37,416</b>
<b>Investments (2009 million Euros)</b>						
All		420	510	608	614	800

**Table 4. Transmission Entities' Annual Revenue Requirements ( 2009)**

Data Source: MITC Order 3801/2007 (2009)

<b>Transmission Company</b>	<b>Annual Revenue Requirements (2009 € Thousands)</b>
Red Eléctrica de España, S.A.	1,129,116
Iberdrola Distribución Eléctrica, S.A.U.	22
Unión Fenosa Distribución, S.A.	40,096
Endesa, S.A. (Peninsular)	7,397
Hidrocantábrico Distribución Eléctrica, S.A.	30,466
Endesa, S.A. (Extrapeinsular)	136,924
<b>Total</b>	<b>1,344,021</b>

Figure 2 depicts the transmission interconnections between Spain and neighboring countries in Europe and Africa. Spain primarily imports power from France and exports power to Portugal, Morocco and Andorra. Thus, Spain could be considered a user of the French networks, whereas the other countries could be thought of as users of the Spanish network. However, the net exports were approximately 3% of



Spain's national electricity consumption in 2009, making international network use a small part of total network use. The statistics are summarized in Table 5.

**Table 5. Electricity Exports to Neighboring Countries (2005 – 2009)**

Source: RED Eléctrica (2009)

Year	Exports / (Imports) (GWh)				Total Exports (GWh)	National Consumption (GWh)	Percentage Exports
	France	Portugal	Andorra	Morocco			
2005	(6,545)	6,829	271	788	1,343	260,688	0.52%
2006	(4,410)	5,458	229	2,002	3,279	268,092	1.22%
2007	(5,487)	7,497	261	3,479	5,750	276,927	2.08%
2008	(2,889)	9,439	278	4,212	11,040	279,182	3.95%
2009	(1,766)	5,239	295	4,630	8,398	266,873	3.15%

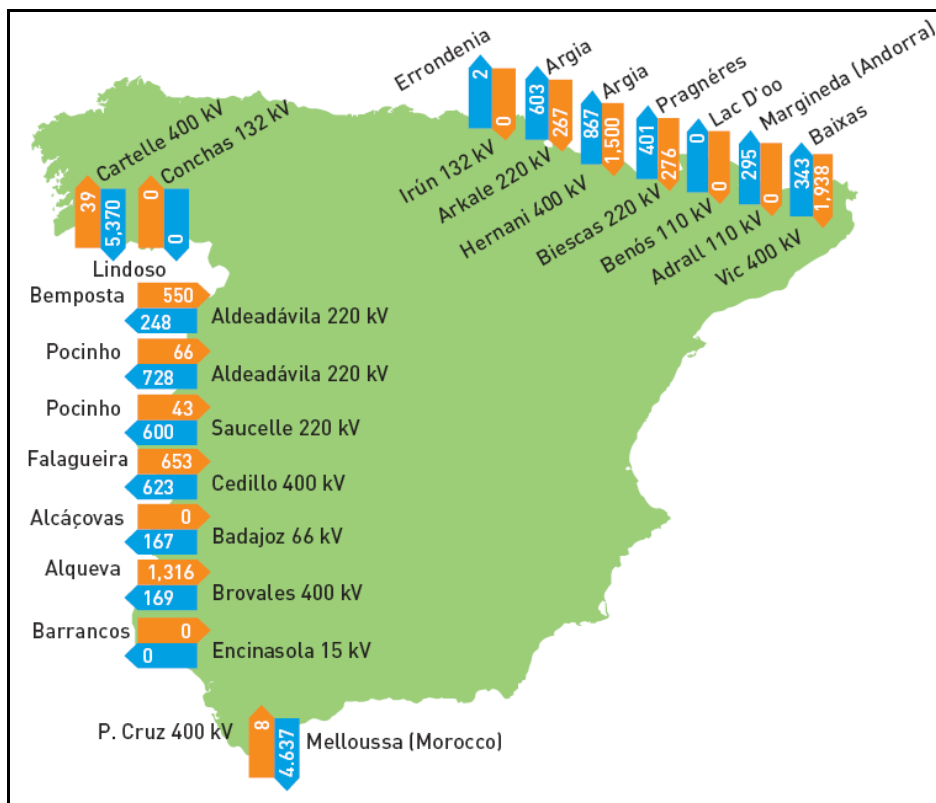

**Figure 2. Transmission Interconnections to Neighboring Countries**

Source: RED Eléctrica (2009)

**Table 6. Distribution Entities' Annual Revenue Requirements and Third Party Access Costs (2009)**

Data Source: MITC Order 3801/2007 (2009)

Distribution Company	Annual Revenue Requirements	Third Party Access Costs
	(2009 € Thousands)	
Iberdrola Distribución Eléctrica, SAU	1,484,625	122,534
Unión Fenosa Distribución, SA	697,630	42,388
Hidrocantábrico Distribución Eléctrica, SA	139,668	7,966
Electra de Viesgo Distribución, SA	134,321	6,861
Endesa (mainland Spain)	1,634,031	113,000
Endesa (extra-peninsular)	325,242	19,841
FEVASA	182	41
SOLANAR	323	9
<b>Total</b>	<b>4,416,022</b>	<b>312,640</b>

Distribution networks in Spain are owned by large investor owned utilities (IOU) such as Iberdrola and Endesa and small local municipal companies. Such companies are responsible for providing network services to customers in their service areas. The large IOUs and some municipal companies offer Tariffs of Last Resort. IOUs offer retail supply through legally separated retail companies. The annual revenue requirements of the large IOUs and the Third Party Access (TPA) or connection costs are listed in Table 6. These costs are recovered from all customers through the access tariffs, as set by the MITC.

## 2. TARIFFS

Spain has two distinct tariff designs: Tariffs of Last Resort (ToLR) and retail tariffs. The Tariff of Last Resort is a regulated integral tariff comprised of the energy, energy policy and network-related costs. In competitive retail tariffs, the charges for network-related costs and some energy policy costs are regulated, while the other components are influenced by the retail market. In Spain, the tariff components that pertain to the network-related costs and the regulated energy policy costs are collectively called "access tariffs," as they represent the costs for accessing the network. The term access tariff will therefore be used hereafter in the Spanish context, instead of "network tariff."

The most important characteristic of the access tariffs in Spain is that they are uniform across the entire country. They are differentiated by voltage category, but not by geographical location. This characteristic introduces economic distortions in network cost allocation because network access in some regions is subsidized by consumers in others.

An important implication of the Spanish tariff designs is that the final rates are not decomposable into their constituent components by inspection. That is, the final rate cannot be separated into costs of

energy, network or other costs because end users see a single rate, as published by the rate-setting authority.

## 2.1 General Tariff Design

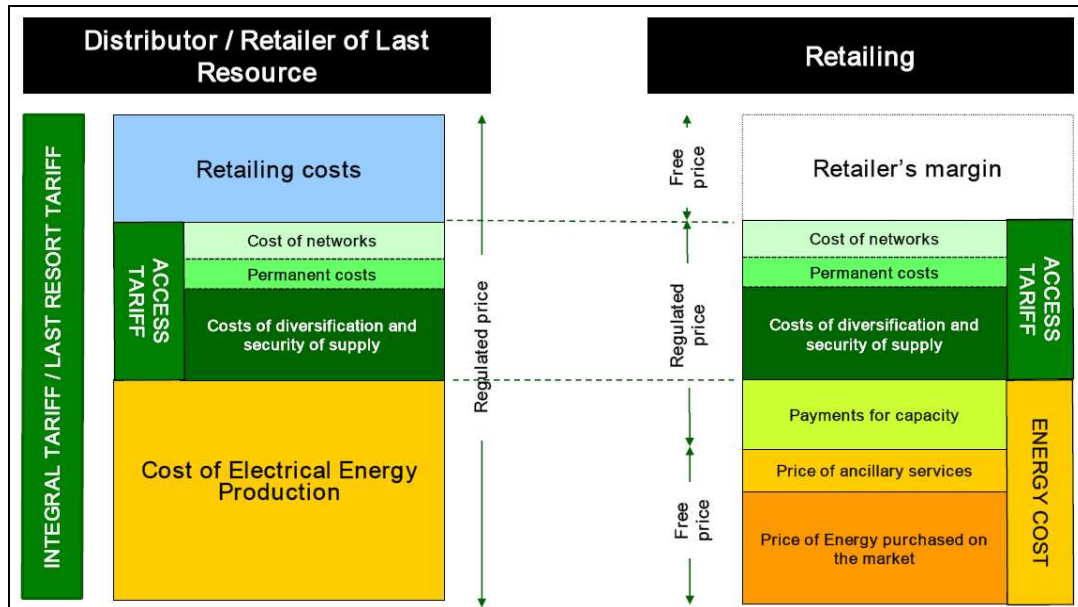

Figure 3. Cost Components in the Spanish Network Tariff Designs

Source: CNE (2009)

Figure 3 depicts the components of the two different Spanish tariff designs. The ToLR design results in a regulated final price of electricity, and is comprised of energy, network, energy policy and commercial or retail costs for distributors. The retail design is also comprised of the same costs components, but the final price is not regulated. The price for energy is based on the retailers' energy procurement costs in the wholesale electricity market. Retail suppliers have discretion over their commercial or retail margin. The access tariffs and charges for capacity payments are regulated. As such, the retail tariff design is similar to those in electricity systems with competitive retail sectors.

Table 7 describes the general tariff architecture for the Spanish access tariffs, for both transmission and distribution networks and energy policy costs.

Connection charges in Spain differ by customer category. Generators and distributed generators pay dedicated or deep connection charges that include costs for direct connection to the network and network reinforcements. Charges are in the form of an annual capacity charge (€/kW/year). Very small customers that subscribe to a protected social tariff category are exempt from connection charges. All other end-users are responsible for an average connection charge that is inclusive of direct connection

costs and network reinforcements. Both types of connection costs are included in the annual revenue requirements of the distribution company in a separate line item under the name Third Party Access (TPA). The TPA costs are then aggregated across all the major distribution companies and subsequently included in the access tariff, as shown in Tables 6 and 8. Connection costs are passed through to customers as an average price differentiated by capacity. Small, medium and large customers pay a fixed annual capacity charge (€/kW/year). Connection charges influence siting decisions for generators in the Spanish system, but not for consumers because consumers pay a charge that is a system-wide capacity-weighted average.

**Table 7. General Tariff Design in Spain**

	<b>Cost Components</b>	<b>Customer Type</b> (by consumption)	<b>Cost Allocation</b>	<b>Rate Structure</b>
<b>Connection Charges</b>	Connection assets; Network reinforcement	Generator	Dedicated (deep)	Fixed annual capacity charge (€/kW/year)
		Large	Average by voltage category	Fixed annual capacity charge (€/kW/year)
		Medium	Average by voltage category	Fixed annual capacity charge (€/kW/year)
		Small	Average by voltage category	Fixed annual capacity charge (€/kW/year)
		Very small	None	None
		Distributed Generator	Dedicated (deep)	Fixed annual capacity charge (€/kW/year)
<b>Distribution UoS Charges</b>	Shared network use; Common services like system control; Administrative costs of network operation	Large	Average by voltage category and capacity	Annual capacity (€/kW/year) and volume (€/kWh)
		Medium	Average by voltage category and capacity	Annual capacity (€/kW/year) and volume (€/kWh)
		Small	Average by voltage category and capacity	Annual capacity (€/kW/year) and volume (€/kWh)
		Very small	Average by voltage category and capacity	Monthly capacity (€/kW/month) and volume (€/kWh)
		Distributed Generator	None	None
<b>Transmission UoS Charges</b>	Shared network use; Common services like ancillary services; Administrative costs of network operation	Generator	None	None
		Large	Postage stamp	Annual capacity (€/kW/year) and volume (€/kWh)
		Medium	Postage stamp	Annual capacity (€/kW/year) and volume (€/kWh)
		Small	Postage stamp	Annual capacity (€/kW/year) and volume (€/kWh)
		Very small	Postage stamp	Annual capacity (€/kW/year) and volume (€/kWh)
<b>Commercial Services</b>	Meter installations and reading; billing services	All	Average	Fixed monthly (\$/month)
<b>Energy Policy</b>	Renewable Energy	All	Average by voltage category and capacity	Fixed monthly (\$/month)
	Others	All	Average by voltage category and capacity	Fixed monthly (\$/month)

Distribution Use-of-System charges are calculated by voltage level. The Spanish CNE uses a network model to allocate costs and determines network usage at each voltage level, weighted by peak demand.

Customers pay an average charge based on the voltage level to which they are connected, weighted by their capacity. Small customers pay a fixed annual charge (€/kW/year) and also a charge that varies by consumption volume (€/kWh). Medium and large customers pay fixed monthly charges (€/kW/month) and also by consumption volume (€/kWh). Distributed generators do not pay for network use.

Transmission Use-of-System charges are also calculated as an average across all transmission level customers, weighted by their capacity. The average charge is, in effect, a postage stamp rate because of a single transmission network across the entire country. Transmission level charges for network use are passed through to end-use customers in the final access tariff. These charges appear in the form of a fixed monthly or annual fee (€/kW/year or €/kW/month), depending on customer type, and a charge that varies by consumption volume (€/kWh). Generators do not pay use for network use. As a result, the cost of network usage does not influence generator's siting decisions. Even if generators were to pay for network usage, the postage stamp rate would not provide a locational signal for the cost of network services at the transmission level. However, congestion costs included in the wholesale energy price will partly influence generators' siting decisions.

Charges for commercial services such as meter reading, billing and other administrative expenses are calculated as an average across all customers connected to the electricity system. Such charges are recovered through a fixed monthly charge (€/month), which is added to the other fixed monthly connection and Use-of-System charges.

All customers connected to the network are responsible for a number of fixed charges designed to recover costs related to energy policy. These include payments to the nuclear sector, fees for market operation and the National Energy Commission (CNE), the Special Prime System and the deficit of regulated activities. The costs are itemized in Table 8. Total payments for nuclear moratoria and fuel processing are allocated as a fixed percentage of the total transmission and distribution costs to the different customer categories. The same process is used for Commission fees and market operation dues. The costs of the Special Prime system, subsidies to populations in the island groups, and the regulated deficit are allocated using the Ramsey principle, in a manner that is inversely proportional to consumers' price elasticity of demand. That is, customers with relatively inelastic demand are allocated a higher proportion of such costs than customers with relatively elastic demand. Such charges are passed through in the form of fixed monthly (€/month) or annual charges (€/year) depending on customer type.

Table 8 lists the cost types that are included in the access tariffs and their relative contribution to the total access cost. Approximately 47% of the access tariffs can be attributed to the capital and operating costs of networks. Distribution (76%) represents the largest share of network costs, followed by transmission (19%). Third Party Access (TPA) or connection costs across the entire electricity system are also

included in access tariffs, but are only 5% of network costs. Lastly, system operation costs incurred by RED Eléctrica as the Transmission System Operator contribute less than 1% to the total network costs.

**Table 8. Cost Components in the Spanish Access Tariff**

Source: CNE (2009)

<b>Cost Item</b>	<b>Cost</b> (2009 € Millions)	<b>Percentage Cost</b>
<b>Network Costs</b>		
Transmission	1,293	19.3%
Distribution	5,072	75.5%
Third Party Access (TPA) (connection costs)	313	4.7%
System Operation	38	0.6%
<b>Sub-total</b>	<b>6,715</b>	<b>100%</b>
<b>Energy Policy</b>		
Diversification and Security of Supply	824	11%
Nuclear moratorium	3	
Nuclear fuel cycle	71	
Market interruptibility system	750	
Special Prime System (Renewables and Cogeneration)	4,009	52%
Deficit of Regulated Activities	1,468	19%
Fixed Costs	1,391	18%
Extra-peninsular Compensation	1,295	
Market Operation	11	
National Energy Commission	20	
Other fixed costs	65	
<b>Sub-total</b>	<b>7,692</b>	<b>100%</b>
<b>Total</b>	<b>14,407</b>	

The energy policy components (53%) of access tariffs include a variety of costs, as listed in Table 8. Over 50% of energy policy costs can be attributed to the Special Prime System (or Special Regime), i.e. incentive payments to large-scale renewable energy and cogeneration sources, and distributed generation. Another 20% can be attributed to an access tariff deficit, explained in further detail in a later section. Energy and network access subsidies to the populations living in the island groups such as the Balearic and Canary Islands comprise over 90% of the fixed energy policy costs (18%). Consequently,

energy policy costs that are unrelated to the costs of network ownership and operation are more than half of the total access costs in the Spanish system.

In summary, the network costs in Spain are added to costs that are incurred due to energy policy and allocated to different customer categories through regulated access tariffs. Each of the network and energy policy costs contributes roughly 50% to the access tariffs. The access tariffs are common to both the tariffs of Last Resort and the competitive retail tariffs. Customers pay an average charge for their voltage level, weighted by their monthly or annual capacity. Customers also pay variable charges as a function of their energy consumption.

Although the different cost categories can be itemized for the purpose of cost allocation, the final prices cannot be decomposed into to the constituent components as evidenced by the final rate structure.

## **2.2 Rate Design**

The Spanish Ministry of Industry, Tourism and Commerce (MITC) calculates and publishes the final rates for the Tariffs of Last Resort, which are updated annually. Inputs such as energy costs, access tariffs and retail margins for the distribution companies are included in the calculation. The specific formulas and methodology used to arrive at the final rates is not published. The National Energy Commission is required to propose the cost allocation method to the Ministry, based on its models and data submitted by the generators, network companies and retailers. However, the Ministry has final authority over the method used and published rates.

Table 9 lists the Tariffs of Last Resort that came into effect on July 1, 2009. Both residential and business customers at low voltage levels (< 10 kW) are covered by these tariff categories. Distribution companies in Spain are required to offer ToLR to such customers. Customers sign an annual contract with the distribution company and are charged annual capacity charges (€/kW/year) and energy charges (€/kWh) based on the volume of electricity consumed. A time-of-use option with peak and off-peak rates is also available. The ToLR is applicable only to connections below 10 kW; consumers are placed on ToLR service unless they choose to contract with a retail supplier.

Two tariff categories within the ToLR are designed for special consumer groups. Small residential customers in low-income groups, or senior citizens may qualify for the “Social Rate,” a subsidized tariff under the ToLR arrangement. Such customers pay reduced fixed monthly and energy charges. They can also elect for the time-of-use option. Other groups such as small rural customers that would not otherwise be able to afford electricity costs are eligible for the “Social Allowance.” Rates are further subsidized in this category, with no obligations for fixed monthly or annual charges for customers connected at < 3 kW. Such customers only pay for the energy consumed. Customers connected at < 1

kW pay a very small fixed monthly fee, and for the energy consumer. The Social Rate and the Social Tariff are only available to residential customers.

**Table 9. Tariffs of Last Resort (ToLR) in Spain (2009)**

Data Source: MITC Order 1659, 1723/2009, CNE (2009)

Connection Capacity	Time-of-Use Variations	Fixed Charge	Variable Charge
<b>Residential and Business</b>		( € / kW / year)	( € / kWh)
< 10 kW	Single rate	20.102	0.115
< 10 kW	Peak	20.102	0.137
	Valley		0.061
		( € / kW / month)	( € / kWh)
10 kW <...<15 kW	Single rate	2.080	0.133
10 kW <...<15 kW	Peak	1.859	0.143
	Valley		0.063
> 15 kW	Peak	1.859	0.150
	Flat		0.121
	Valley		0.082
<b>Social Rate</b>		( € / kW / month)	( € / kWh)
< 10 kW	Single rate	1.642	0.112
< 10 kW	Peak	1.642	0.135
	Valley		0.060
<b>Social Allowance</b>			
< 3 kW	Single rate	0.000	0.112
< 1 kW	Single rate	0.402	0.089

The MITC published reference tariffs for customers above 10 kW who are still on integral tariff contracts under historical arrangements. Such customers are now subject to the pricing scheme listed in Table 9 (10 kW <...<15 kW, and > 15 kW) until December 31, 2009, by when they are expected to have transitioned to retail arrangements. The published reference tariffs for these categories are integral tariffs, similar to the ToLR.

Medium and large customers are not eligible for tariffs of Last Resort and must therefore contract with retail suppliers for electricity. The distribution company continues to serve as the billing agent. The MITC publishes the access tariffs for customers who currently procure energy from retail suppliers, as shown in Table 10. For connections between 10 and 15 kW a two-part access tariff is offered. Customers with connection capacities greater than 15 kW can choose between three-period or six-period time-of-use



tariffs. Customers connected at voltage levels greater than 36 kV are automatically placed on six-period time of use tariffs, as shown in Table 10. Figure 4 depicts the how the time periods are organized, with daily and monthly variations. Medium and large customers also pay charges for reactive power based on the amount of reactive power necessary (€/kVArh) to maintain the quality of power of their connection. The unit charge decreases as the power factor of the customer's load increases, as shown in Table 10.

**Table 10. Access Tariffs for Medium and Large Customers in Spain (2009)**

Data Source: MITC Order 1723/ 2009 (2009)

Capacity (at < 1 kV)		Fixed Capacity Charge (€/kW/year)	Energy Charge (€/kWh)
10 kW<...<15 kW	Period 1 Period 2	24.34	0.065 0.017
> 15 kW	Period 1 Period 2 Period 3	10.89 6.53 4.35	0.048 0.033 0.013

Voltage Category	Period 1	Period 2	Period 3	Period 4	Period 5	Period 6
	Fixed Capacity Charge (€/kW/year)					
1 - 36 kV	13.12	6.57	4.81	4.80	4.81	2.19
36 - 72.5 kV	11.30	5.65	4.14	4.14	4.14	1.89
72.5 - 145 kV	10.61	5.31	3.89	3.89	3.89	1.77
>= 145 kV	9.86	4.93	3.61	3.61	3.61	1.65
	Energy Charge (€/kWh)					
1 - 36 kV	0.046	0.038	0.022	0.012	0.008	0.006
36 - 72.5 kV	0.015	0.012	0.007	0.004	0.003	0.002
72.5 - 145 kV	0.012	0.010	0.006	0.003	0.002	0.002
>= 145 kV	0.009	0.008	0.005	0.003	0.002	0.001
<b>Power Factor</b>	Reactive Power Charge (€/kVArh)					
0.90 <...< 0.95	0.000013					
0.85 <...< 0.90	0.017018					
0.80 <...< 0.85	0.034037					
<...< 0.80	0.051056					

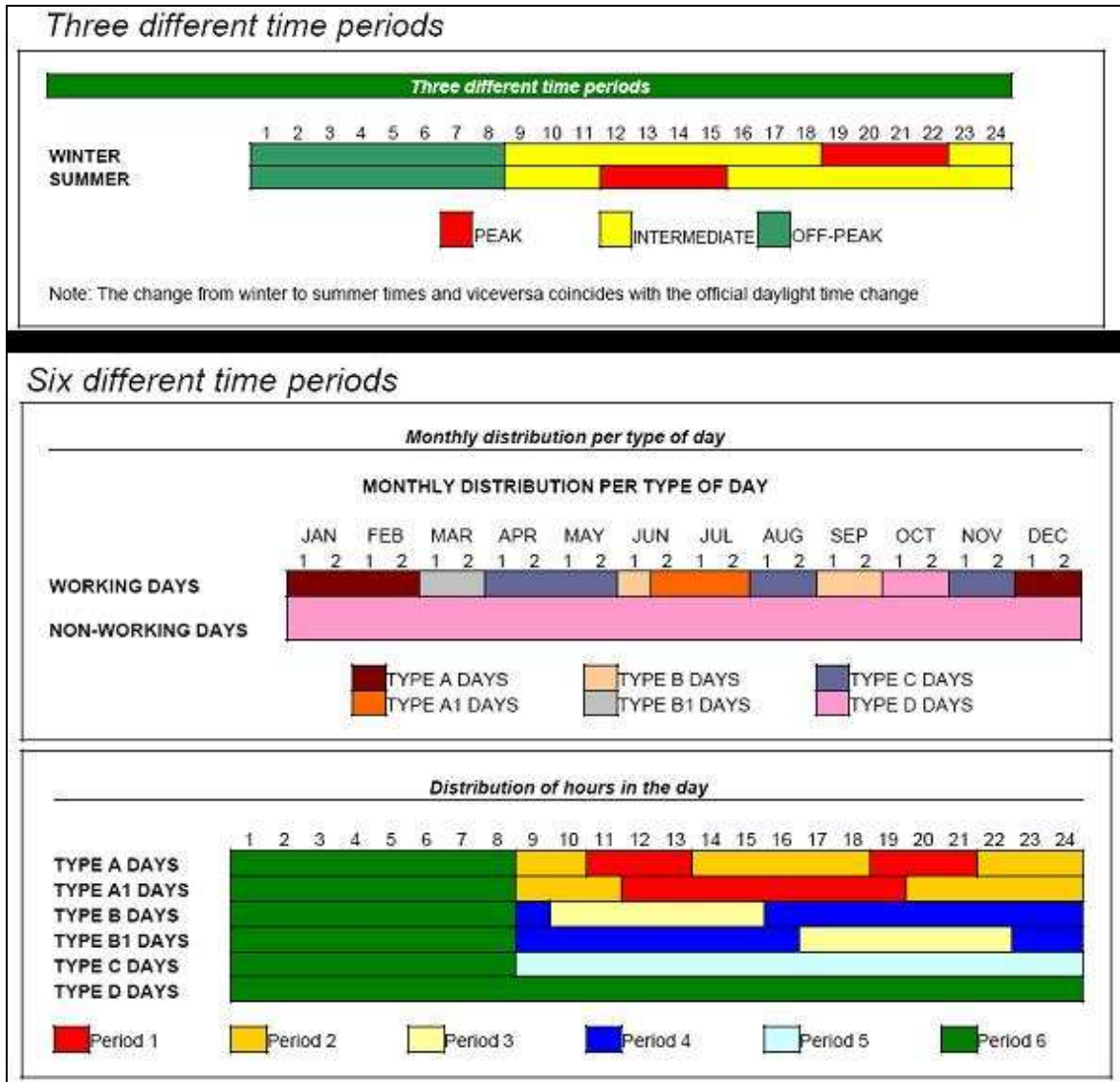

Figure 4. Time-of-Use Periods for Medium and Large Customers in Spain (2009)

Source: CNE (2009)

Selected retail prices for medium and large customers for a single contract year are listed in Table 11. The rates offered by Iberdrola S.A., a large distribution company that also has a legally separated retail business, are used for the purpose of this analysis. Customers with connections below 10 kW are offered retail prices identical to the ToLR rates published by the MITC. Customers with connections greater than 10 kW are offered contract rates determined by Iberdrola. A comparison with Table 10 indicates the difference between the access tariff rates and the retail rates. Iberdrola's retail rates are higher in each case, and the difference can be attributed to the costs of energy and the company's retail margins. The

difference appears mostly in the energy charge component (€/kWh). Although the examples used here are specific to Iberdrola, the general retail tariff design is similar across retail suppliers in Spain.

**Table 11. Retail Tariffs for Medium and Large Iberdrola Customers (2009)**

Data Source: Iberdrola (2009)

Connection Capacity	Time-of-Use Variations	Fixed Charge	Variable Charge
		(€ / kW / year)	(€ / kWh)
10 kW <...<15 kW	Single rate	25.207	0.127
	Peak	25.525	0.143
	Flat	25.525	0.061
	Valley	25.525	0.061
> 15 kW	Peak	11.263	0.143
	Flat	6.758	0.115
	Valley	4.505	0.078

Customers that are connected at voltage levels greater than 1 kV are not offered pre-determined retail contracts, but are offered negotiated rates which include the access tariffs as a component. Larger customers can effectively negotiate energy supply contracts with retail suppliers, because the regulated access tariff is simply passed through to such customers. The six-period time of use access tariff is designed to reflect the costs of delivering network services at different times of the day and year. However, this design may not accurately reflect such costs because the proportion of fixed energy policy related costs included in the access tariff is quite large. The fee for reactive power provides such customers with the incentive to maintain their load at a high power factor; a power factor very close to unity allows such customers to minimize or avoid reactive power charges.

### 2.3 ToLR Distortions

Integral tariffs like the Tariffs of Last Resort may introduce significant distortions in the economic performance of the electricity industry because the incurred costs may be significantly higher than the annual revenue requirements originally approved. Consequently, the regulated rates may not always be sufficient to recover the incurred costs. In most cases, annual settlements are sufficient to reconcile any deviations of the incurred costs from the expected revenue requirements, with minor rate impacts in subsequent years. However, the distortion is acute when the realized costs deviate significantly from the expected costs in a given year, and the deviations cannot be settled in the following annual review period due to significant rate impacts. The energy cost component of the regulated ToLR is prone to such

deviations because the rate does not reflect the volatility in the costs of energy procured in the wholesale electricity market. The ToLR rates thus lock-in an expected price of energy. In the competitive retail sector, energy prices are passed through to customers in each billing cycle, through which retailers can recover their energy costs. The distortion is therefore limited to the regulated tariff segment of the industry, affecting the regulated entities operating in that segment. In the Spanish system, such a distortion has been observed in the form of annual tariff deficits between 2000 and 2009, because the realized energy costs have been much higher than expected costs. Table 12 lists the tariff deficit as recognized by law for the period 2000-2008, amounting to approximately € 14.5 billion, of which little over € 2 billion have been recovered. The estimated deficit as of 2009, which includes the estimated incremental deficit of the year 2009, amounts to approximately € 15 billion. By law, the unrecovered portions of the deficits realized in each time period have been annuitized for recovery over the next 12 – 13 years.

**Table 12. Estimated Tariff Deficit (2000 – 2009)**

Data Source: CNE (2009)

Category	Deficit Value as Recognized by Law	Recovery Pending as of Dec 2008	Prescribed Recovery Annuity Value as of 2008	Estimated Recovery Pending as of Dec 2009	Pending Annuities (years)
	(million Euros nominal)				
Mainland Supply (2000 - 2002)	1,522.33	417.71	220.90	214.52	1
Extrapeninsular Islands' Supply (2001 - 2002)	387.81	264.33	140.27	135.26	1
Extrapeninsular Islands' Supply (2003 - 2005)	533.41	471.99	48.72	443.27	12
Mainland Supply (2005)	3,830.45	3,498.72	379.05	3,270.01	11
Mainland Supply (2006)	2,279.94	2,082.72	211.45	1,960.77	12
Mainland Supply (2007)	1,244.44	1,214.28	119.54	1,154.81	13
Mainland Supply (2008)	4,745.02	4,494.71	348.49	4,339.36	13
<b>Sub-total</b>	<b>14,543.39</b>	<b>12,444.46</b>	<b>1,468.41</b>	<b>11,518.00</b>	
Mainland Supply (2009) (estimated)	-	-	-	3,484.63	N/A
<b>Total</b>	<b>14,543.39</b>	<b>12,444.46</b>	<b>1,468.41</b>	<b>15,002.63</b>	

The cause of the deficit is mainly attributed to the differences in the expected and realized costs of electrical energy in the wholesale electricity market, and the exceptionally large payments made to generators under the Special Regime. Data on the value of payments to SR generators was not found. Figure 5 compares the distribution companies' average prices and their realized energy costs (€/MWh) for the period 1998-2009 (upper graph), and the corresponding deficit (€ billions) (lower graph). The lower graph indicates two types of deficits - "ex post," realized in 2000-2002, 2005 and 2006, and "ex ante," realized in 2007-2008. In the ex post deficit, the revenues collected based on the pre-set regulated tariff charges were found to substantially under recover the costs, after the annual billing and settlement cycle. In other words, the ex post deficits were not expected to occur, because the shocks were realized during the cycle. On the contrary, the ex ante deficit recognizes that revenues collected during the subsequent annual cycle will be insufficient to cover costs incurred during cycle. That is, the costs incurred are expected to exceed the revenues collected.

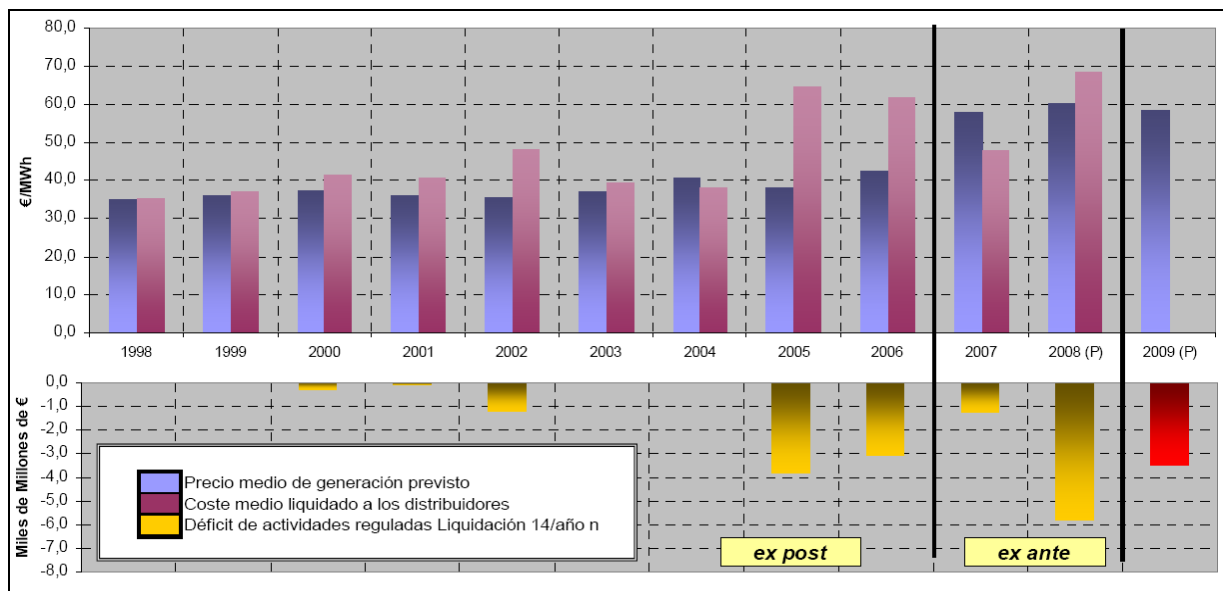
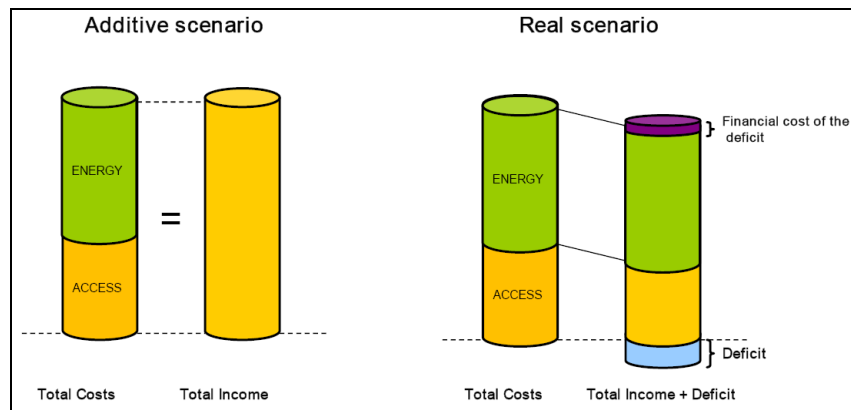

**Figure 5. Distributors' Revenue and Cost Deviations and Resulting Deficits (2000 – 2009)**

Source: CNE (2009)

Figure 6 is a schematic of the process for creating an ex ante deficit. The "additive scenario" on the left describes the ideal situation where the total costs of electricity comprised of energy and access costs are fully recovered through revenues based on the pre-set regulated rates. The "real scenario" on the right describes a situation where the total income is artificially lower than the incurred costs to maintain low electricity rates. The deficit introduced (shown in blue) is called the ex ante deficit. Rate shock is minimized by allowing only a small portion of the deficit (either current or accumulated) such as an annuitized amount to be collected in addition to the artificially lowered costs.

Figure 7 shows a graph of how the ex ante deficit was created for the years 2007-2009. The increasing average access costs (red line) were expected to be higher than the regulated rates (blue line) (upper graph, in c€/kWh). Between 2008 and 2009, a small rate adder or surcharge was included in the regulated rates to recover the annuitized portion of the deficit in previous years. The lower graph depicts the relative levels of accumulating ex post deficits and newly incurred ex ante deficits.



**Figure 6. Schematic for the Creation of an Ex Ante Deficit**

Source: CNE (2009)

Ex ante deficits were justified in the Spanish system on the grounds that electricity customers would not be able to bear the substantial rate increases required to recover the deficits of past years and significant future electricity cost increases. Distributors' financial obligations to generators were ordered to be fulfilled by law to protect the wholesale electricity market. The deficit was allocated to the access tariffs and ordered to be annuitized and recovered as by distribution companies as receipts on long-term debt. Consequently, the unrecovered deficit amounts are a financial obligation on the part of the Spanish government to the regulated distribution companies. Although these companies are assured of eventual deficit recovery in the long-term, the lack of recovery in the short term may have perverse effects on their operations.

The effects of the economic distortion introduced by the regulated ToLR due to high energy costs are evidenced in part by the trend of customers switching from retail arrangements to regulated tariffs, and back to retail supply when energy costs drop. When the retail energy prices rose as a consequence of high energy costs, especially in the middle of a regulatory review period, ToLR rates stayed constant and did not exhibit the magnitude of increase or volatility of the wholesale market. The annual increase in ToLR rate was artificially depressed to keep prices low for most end-use customers. Consequently, many customers in Spain who had switched from regulated tariffs to competitive retail contracts during the course of restructuring began to switch back to ToLR between 2003 and 2008. Figure 8 depicts this trend graphically. Between 2003 and 2008, the total number of customers in the retail market increased, along

with the corresponding increase in the total consumption of electricity in the retail segment. However, some customers appear to have switched back to ToLR tariffs between 2006 and 2008. Further, total retail consumption in 2008 appears to have returned to the pre-2006 level before switching was observed. Although customers could have switched from regulated tariffs to retail supply for reasons other than energy prices, such as the increasing availability of retail contracts due to a growing number of suppliers or more favorable contract terms, it is plausible that the switching back to regulated tariffs was primarily due to the assurance of lower rates through ToLR tariffs. The effects and trends are likely to be different for commercial and industrial customers, compared to small residential customers.

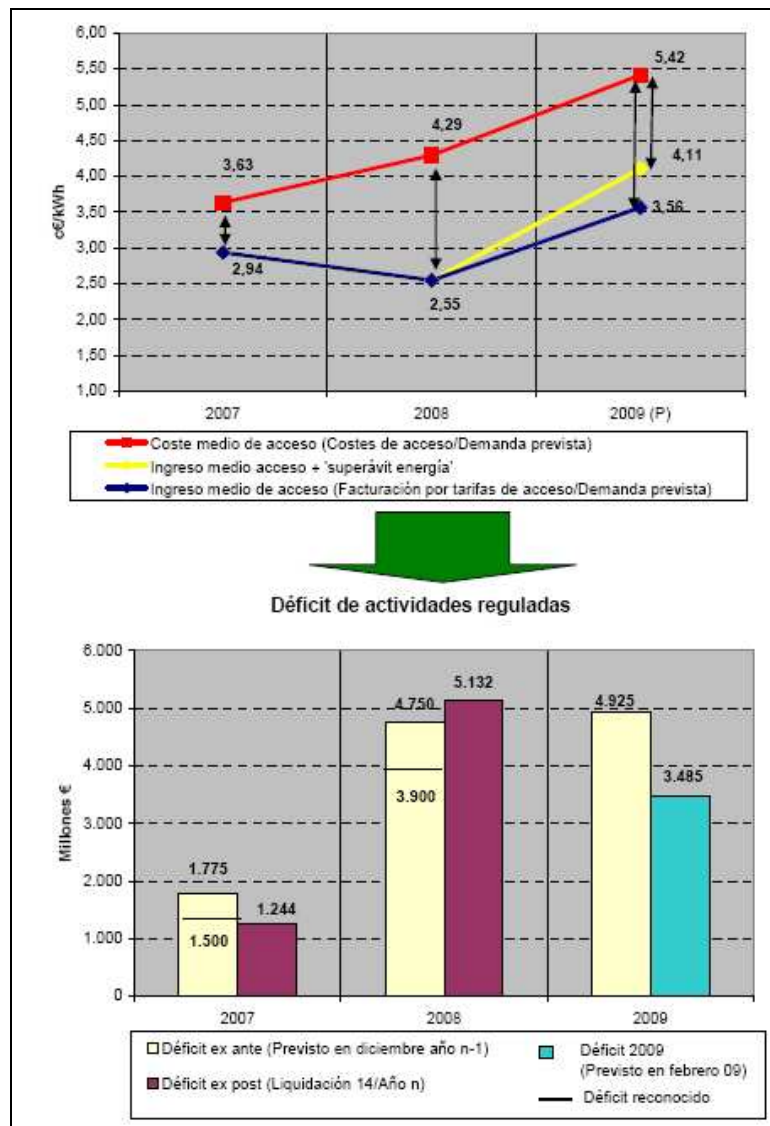
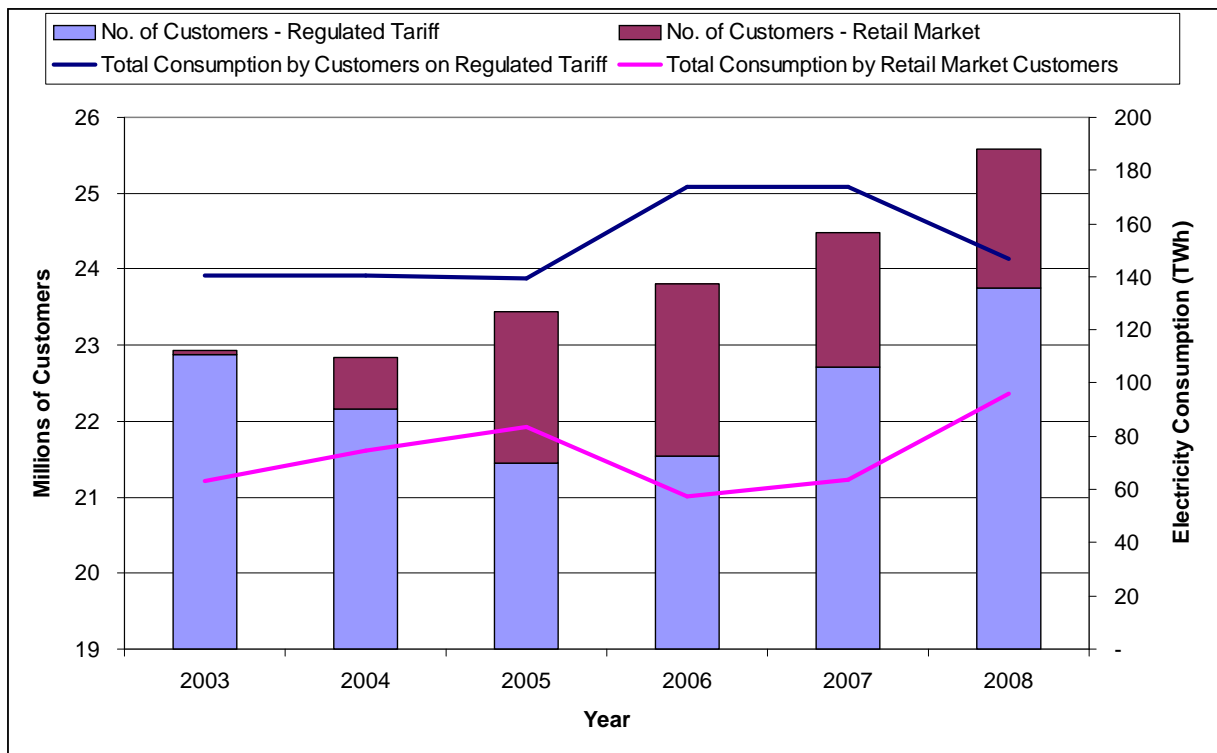

Figure 7. Regulated Tariff Rates and Corresponding Deficit Levels (2007 -2009)

Source: CNE (2009)



**Figure 8. Regulated Tariff Rates and Corresponding Deficit Levels (2007 -2009)**

Data Source: CNE (2009)

As described earlier, a major share of the deficit can be attributed to large payments made to SR generators. Of the SR generators, distributed generators are also indirectly provided network subsidies in addition to special energy rates through the SR mechanism because they do not pay Use of System charges to the network company while supplying electricity to the grid. These generators receive special rates for the net metered electricity supplied, as described in Table 2. When such generators consume more electricity than they generate, they are charged according to the appropriate customer category for the net electricity consumed. On the other hand, they receive payments when they supply surplus electricity back to the distribution network. In many cases, the special tariff rate used is higher than the final ToLR rate or retail tariff rate. Furthermore, payments to distributed generation under the SR are recovered from all customers through the access tariff. In effect, distributed generators are subsidized because they are paid for using the network when they supply to the grid, and these costs are borne by end-use customers.



## CONCLUDING REMARKS

From the initial discussion of the economics and principles of electricity network tariff design and the subsequent country studies, we gather that the process of designing tariffs is replete with choices and trade-offs. The variety of choices and some of their consequences are observed in the individual country studies. Tariff designs are influenced by the underlying physical characteristics of the electricity network such as the geographical footprint, the number and relative concentration of users, characteristics and location of generation, etc. The economic properties of networks – economies of scale and scope and public good aspects – must be reconciled with their physical properties to ensure their sustainability. The task of reconciliation is not always easy to accomplish and this is where the trade-offs and choices become important. In response to the recurring question of “what is the ideal tariff design?” we therefore conclude that there is no ideal tariff design that can be derived based purely on the technological or economic features of a network. Rather, the tariff design is driven by a delicate balance between the network features and the policy goals of the particular system. To put it more directly, there is an ideal tariff design that can be devised for any policy objective, given the unique features of any network. The appropriate question on the subject of network tariff designs should therefore be “what is the ideal tariff design for policy objective X or Y?”

The primary policy goal of the tariff design is to recover the total costs incurred in providing network services to all network users. This goal dictates that the total incurred costs must first be estimated or measured before they can be collected. That is, the first step of implementing a tariff design is determining the annual revenue requirements for a network. Observations about the relative ARR for networks in different countries indicate that the amounts include not only network-related capital and operating expenses, but also more general costs incurred due to a variety of energy policies. The costs of energy policy may sometimes overshadow network-related costs in the ARR. As a result the ARR is no longer a useful indicator of the aggregate economic value of the network. Some may dismiss this concern by using the label “access tariff” instead of network tariff. If this is done, network companies effectively become the billing and collection agent for energy policy payments on behalf of the government. Yet, the purported benefits of such energy policy are gained by the entire economy or population and not just electricity network users. Moreover, including large energy policy costs in an access tariff subjects its allocation to various network users by using the rules that have been designed for the cost allocation of network costs. These rules may not be suitable, let alone optimal, for the allocation of general energy policy costs. The severity of this issue becomes apparent when network companies are prohibited from recovering legitimate or reasonable network related costs incurred in the normal course of business. Disallowing or deferring the recovery of such costs sets a precedent that regulators may choose to modify the rules of the game at any point. Such regulatory uncertainty may

seriously harm the economic sustainability of an electricity system. Including large non-network related costs in a network or access tariff and the uncertain regulatory treatment of such costs therefore severely distorts network companies' and users' subsequent incentives for building, maintaining and using the network. Electricity systems should therefore consider other economy-wide approaches for assigning costs and benefits of non-network related energy policy.

Once the annual revenue requirement has been identified, the task of allocating costs to various network users must be performed. In addition to ensuring full recovery of the ARR, the tariff can be designed to achieve a number of secondary policy objectives. These policy objectives significantly influence the outcomes regarding the availability and use of the network, and the outcomes may be different for different network users. For instance, if generators pay shallow connection charges, they have no incentive to select a generation technology that minimizes the cost of network reinforcements. However, they may still have an incentive to locate closer to the network to minimize their connection charge. Similarly, a large industrial customer's choice of location and connection capacity could also be affected if electricity is a large cost factor in its production process and it is responsible for large connection and capacity charges. Additionally, if generators are not responsible for network Use of System charges, they may not have an incentive to locate close to the load they wish to serve and may instead select a location that minimizes their costs of generation. This decision may impose network development costs that have to be recovered only from end-use customers, even though generators benefit from using the shared network. Recognizing that the network charges to the generators will ultimately be passed through to end-use customers in any case may create the impression that such charges are meaningless. However, if the generator is required to include these charges in its production decisions, its competitiveness in the wholesale market for generation may be affected. In the context of this discussion, the issue that merits examination in every electricity system is not whether generators or certain types of end-use customers should be made to pay Use of System charges, but whether requiring them to do so can achieve the policy objective that the system designers have in mind based on the incentive structures that are created. Holding some network users responsible for certain types of charges affects the incentive structures that they see, even though all costs are ultimately passed through to end-use customers. The network tariff design is therefore not intrinsically good or bad, or ideal or non-ideal, but a judgment about the quality of a design should be based on its effectiveness in achieving the desired outcome.

Another area of trade-offs in tariff design arises out of the fact policy objectives can sometimes conflict. Tariffs that are designed to achieve one outcome may often be ill-suited to achieve others. For instance, if the objective is to maintain simplicity so that network users can understand the tariffs, then it is likely that the ideal design for this purpose is some type of average cost allocation which results in average rates such a postage-stamp rates. On the other hand, if the objective is to have tariffs that are efficient in terms of allocation, then a complex reference network model could be used to developed detailed and specific tariff rates. However, such a model would not be very comprehensible to most, thereby

decreasing its usefulness in many cases. Thus, the trade-off here is between simplicity and efficiency, and one may be valued more than the other in a particular system. Similar trade-offs can be identified with regard to the other tariff design principles or policy objectives.

Tariff designs can often create cross-subsidies between various types of network users. In such cases, a subset of users typically imposes higher network-related costs on the system than other users, but the charges for all users are identical. In effect, the latter group of users subsidizes the former. One example of this is the provision of network services to customers who live in rural areas, or far away from load centers. Many systems have chosen to charge such customers rates identical to those faced by customers in urban areas or close to load centers, to serve the objective of equality in rates. In this situation, the urban customers are subsidizing the provision of network services to rural customers. Although this policy choice is often questioned by advocates of economically efficient tariffs, it can be justified on the grounds that networks are shared and it is difficult to separate network assets that are used for purely urban delivery from those used for rural delivery. Providing lower rates to low-income or disadvantaged consumer groups is a more explicit form of subsidy. The costs imposed by such customers on the system are borne by all other customer categories, and could be questioned on the grounds of efficiency. However, such a tariff design accomplishes the objective of universal access to all customers within the footprint of a system. Tariff designs that include cross-subsidies to further one or more policy objectives can be better justified if the process for calculating the subsidies and the impact on various network users is transparently presented while making a case for the design.

Perverse incentives can be evidenced when some types of network users are paid for using the network, instead of being charged for network use. For instance, distributed generators use the network when they draw electricity from the grid and are appropriately charged for network use during those times. When they produce more electricity than they consume and supply back to the grid, they are still using the network. Not charging them for network use when they supply electricity to the network is indirectly providing such generators a subsidy. Further, if they are paid a high retail rate inclusive of network-related components or an additional premium for the electricity supplied, they are effectively being paid to use the network. Thus, distributed generators do not have to factor in the costs of network use as compared to the value of electricity supplied while deciding whether to invest in such generators. Moreover, their portion of network costs will likely be borne by other customers in their customer segment. If the policy objective is to provide distributed generators with an incentive, such users could receive a high energy price through a mechanism such as gross metering and still be held responsible for network charges.

There are some issues with respect to which the network tariff design may not be the optimal method for providing users with incentives. Addressing transmission-related congestion or losses through differentiation in the transmission Use of System charges by geographical location is one such issue.

Locational Marginal Pricing is a suitable approach for providing network users with locational signals that include the value of congestion or losses which can be used by generators for site selection, in addition to other incentives that they see based on connection or Use of System charges.

In conclusion, we find that there are a variety of choices and trade-offs that must be made while designing the electricity network tariffs for any electricity system. The tariff design must not only be influenced by the technical and economic characteristics of the system, but also the secondary policy objectives that policy makers wish to achieve, while allowing network companies to recover the costs of building and maintaining the network.

## REFERENCES

### General

Anderson, D., *Regulatory Politics and Electric Utilities: A Case Study in Political Economy*, Boston: Auburn House Publishing Company, 1981

Battle, C., *Electricity Retail Markets*, Florence School of Regulation, 2009

Bonbright, J., A. Danielsen, D. Kamerschen, *Principles of Public Utility Rates*, Arlington, VA: Public Utilities Reports, 1988

Demsetz, H., "Why Regulate Utilities?" *Journal of Law and Economics*, 11(1), 1968, pp. 55-65

Fumagalli, E., L. Lo Schiavo, F. Delestre, *Service Quality Regulation in Electricity Distribution and Retail*, Springer, 2007

Gomez, T., *Electricity Distribution*, Florence School of Regulation, 2009

Jamison, M. et al, "Annotated Reading List for a Body of Knowledge on the Regulation of Utility Infrastructure and Services," prepared for the World Bank, 2004

Joskow, P., R. Schmalensee, *Markets for Power: An Analysis of Electric Utility Deregulation*, Cambridge: MIT Press, 1983

Kahn, A.E., *The Economics of Regulation: Principles and Institutions*, Vol. I & II, Cambridge: MIT Press, 1988

Kirschen, D., G. Strbac, *Fundamentals of Power Systems Economics*, John Wiley & Sons, 2004

Panzar, J., R. Willig, "Economies of Scope," *The American Economic Review*, Vol. 71, No. 2, 1981, pp. 268-272

Olmos, L., I. Perez-Arriaga, "A Comprehensive Approach for Computation and Implementation of Efficient Electricity Transmission Network Charges," Working Paper, Instituto de Investigacion Tecnologica, Universidad Pontificia Comillas

Rivier, J., *Electricity Tariff Design*, Florence School of Regulation, 2009

Rothwell, G., T. Gomez, Eds., *Electricity Economics: Regulation and Deregulation*, IEEE, John Wiley and Sons, 2003

## **Agency Sources**

Australian Energy Regulator

Comisión Nacional de Energía, Spain

Economic Regulatory Authority (Western Australia)

Federal Energy Regulatory Commission, USA

Independent System Operator – New England (ISO-NE)

Massachusetts Department of Public Utilities, USA

Northern Territories Utility Commission (Australia)